



Enhanced seismic base isolation using inertial amplifiers

Sudip Chowdhury^a, Arnab Banerjee^{a,*}, Sondipon Adhikari^b

^a Civil Engineering Department, Indian Institute of Technology (IIT) Delhi, India

^b Aerospace Engineering Department, Swansea University, UK

ARTICLE INFO

Keywords:

Inertial amplification
Inertial amplifier coupled base isolator
Stochastic analysis
Classical base isolator
Inerter-based isolation system

ABSTRACT

Harnessing the concept of inertial amplification, an inertial amplifier coupled base isolator (IABI) is proposed in this paper. The seismic performance, in terms of story drift, base shear reduction, of this proposed inertial amplifier coupled base isolator has been compared with that of the classical base isolator (CBI) and inerter-based isolation system (Inerter-BI). A thorough analytical study, implementing rationals of random vibration for harmonic and Gaussian white noise is conducted to identify the performance of the inertial amplifier coupled base isolator (IABI) in the frequency domain. Further, a numerical study is conducted to determine the story drift, base shear response in time-domain for the inertial amplifier based base-isolated structure and classical base-isolated structure for twenty-two real earthquake ground motions. The results elucidate the histogram of base shear and story drift reduction percentage shifts towards higher values for inertial amplifier coupled isolator compared to CBI and Inerter-BI. From both analytical and numerical study, it is observed that the seismic performance and response reduction capacity of proposed IABI is significantly 89.38% and 72% superior to the classical base isolator and inerter-based isolation system, respectively. This finding evidenced towards the supremacy of the inertial amplifier base isolator over the classical base isolator and inerter coupled base isolator in terms of seismic vibration control.

1. Introduction

The base isolation systems are installed between the structure and foundation to control the seismic responses of the structure. Touaillon's [1] isolation system can be considered as the historical origin of the base isolation system where the base isolator was modelled as double concave spherical sliding bearing isolation system in 1870. The classical base isolation system can be mathematically modelled as a viscously damped two degree of freedom system and its generalized solution is served as the baseline for the designing of the multilayered elastomeric bearings for seismic isolation [2,3]. Decoupling of the structures from the earthquake ground motions is the essence of the seismic base-isolation towards the minimization of inter-story drift and floor accelerations [4]. An appropriate design of the base isolation device absorbs and/or dissipate a significant part of the seismic energy [5,6]. The base isolation devices were exhaustively studied, and widely acclaimed since 1990 [4]. Simplified but useful comprehension can be developed from the analytical solution of a linear classical base isolator [7] consists of two degrees of freedom system with springs, masses and viscous dampers. Additionally, non-viscous [8] or viscoelastic [9] damping in

the context of vibration reduction were also studied and found that [10] a optimally designed viscoelastic tuned-mass damper can out perform a classical viscous tuned-mass damper. Although not investigated in this work, non-viscous or viscoelastically damped systems may have the potential for enhanced isolation. The nonlinear isolators can be perceived by altering the viscous dampers of the linear system with hysteresis damping [11–13]. Lead rubber bearing [14], New Zealand bearing [15], Friction-Pendulum system [16], Resilient Friction Base Isolator [17] and Pure-Friction system [18] are some examples of the nonlinear base isolation devices which results in the hysteresis damping. Among the nonlinear systems friction pendulum system (FPS) is provided a larger isolation period which makes the base of the isolated structure more flexible and its high re-centring capacity decouples the mass of the main structure from the ground during earthquakes [19–23].

On the other hand, an inerter is applied in the traditional vibration control devices to enhance its energy dissipation capacity by massive effective mass amplification through rotational mass with motion transformers [24,25] inside the system. The inerter was first introduced by Smith [26,27] from the force to the current analogy for mitigation of vibration responses of the structures. Since then, these inerters have

* Corresponding author.

E-mail addresses: sudip.chowdhury@civil.iitd.ac.in (S. Chowdhury), abanerjee@iitd.ac.in (A. Banerjee), s.adhikari@swansea.ac.uk (S. Adhikari).

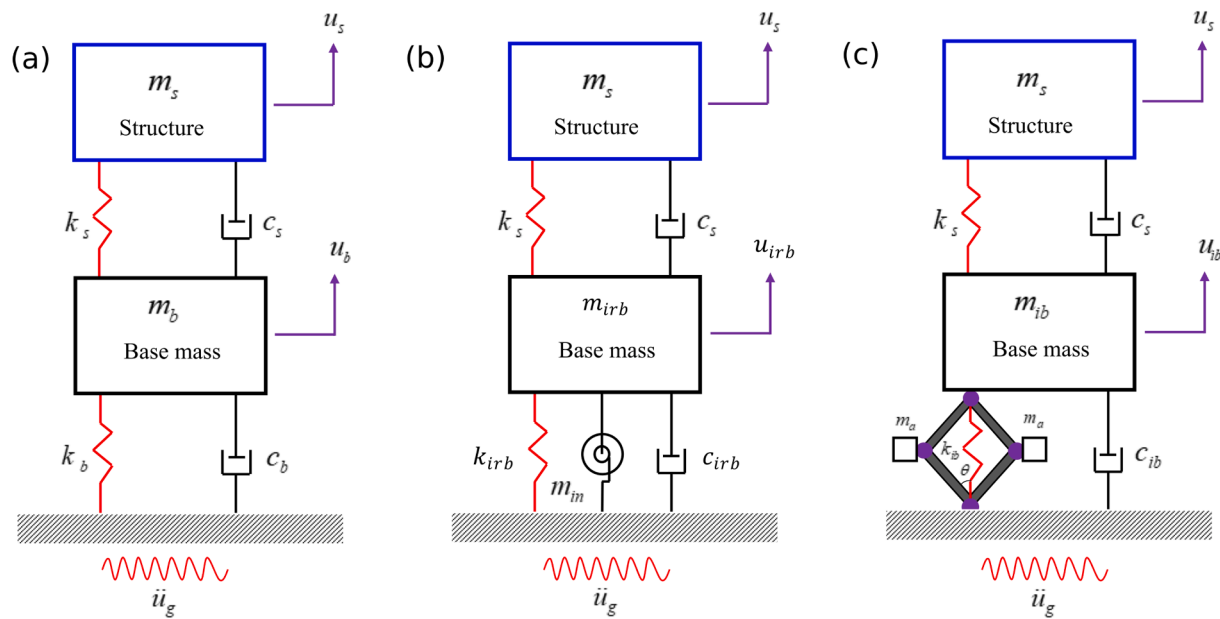

Fig. 1. Schematic diagrams of dynamic systems isolated by (a) classical base isolator, (b) inerter-based isolation system, (c) inertial amplifier coupled base isolator.

widely been implemented in mechanical systems as vibration control devices, especially for automobiles [28–33]. Recently, Kuhnert et al. [34] critically reviewed the advantages and disadvantages of the inerter-based vibration isolation systems. Most of the previous inerter based isolation devices are made by flywheel-gear inerter [35,36]. Inerters were often used in conjunction with other vibration control devices to enhance its performance [37,38]. For example, Qian et al. [35] enhance the seismic performance of a base-isolated structure with a tuned inerter damper [39]. The seismic performance of the base-isolated structures have been enriched by incorporating the inerter-based systems [40,41]. In this context, the inerter has induced inside the traditional Friction Pendulum system (FPS) system [42] and it is observed that the vibration reduction capacity of traditional FPS has increased [43,44]. Not only for the building frames, the inerter-based isolation systems can also be mitigated the vibrations of the water storage tanks [40,45,46] during any seismic events. These inerter-based isolation systems for vibration control of multi-storied building [47] can be modelled with helical springs and Çakmak et al. [48] studied the vibration fatigue analysis of inerter-based isolation system with helical spring. To optimize the governing parameters of the inerter based base-isolator, h_2 [36] and h_∞ [49] optimization schemes are widely acclaimed.

Apart from the inerter, massive mass amplification can also be obtained by inertial amplifiers and a large wide bandgap will occur at low frequencies [50–53]. This inertial amplifier based isolation system is entirely different [36] from the widely acclaimed flywheel-gear inerter [35,41]. The characteristics of widen band gaps at low frequencies allows these amplifiers to surpass the vibration of low frequency based periodic lattice structures [54,52,55,56], acoustic insulation of walls [57,58], beams [59–62] etc. However, the application of these inertial amplifier in massive civil engineering structure like building [63] and bridges is not extremely studied. Recently, Cheng et al. [64] enhanced a tuned mass damper (TMD) with the help of inertial amplifier mechanism (IAM) and the results showed that the seismic performance of IAM-TMD is superior to the traditional TMD [65–68]. However, an inertial amplifier coupled base isolator is not presented in the existing state of the art.

An inertial amplifier coupled base isolator is introduced in this paper. The massive effective mass amplification occurs due to the geometry of the inertial amplifier which enhanced the vibration reduction capacity of the proposed IABI. The frequency domain and stochastic responses have been evaluated analytically while the time-domain

responses are produced numerically. The sensitivity analysis considering system parameters of proposed IABI have been conducted to investigate the effectiveness of system parameters on structural responses. The dynamic responses of the uncontrolled and controlled structures are compared to evaluate the vibration reduction capacity of the each isolators. In the present study, the vibration mitigation capacity of the inertial amplifier coupled base isolator is evaluated compared to that of the classical base isolator and inerter-based isolation system [40].

2. Structural model and equations of motion

The schematic diagrams of structures isolated by classical base isolator (CBI), inerter-based isolation system (Inerter-BI), and inertial amplifier coupled base isolator (IABI) are presented in 1 (a), (b) and (c). It is considered that the isolated structures are subjected to ground motions \ddot{u}_g . In 1 (a), m_b, c_b, k_b refer the base mass, damping, and stiffness of the CBI. u_s and u_b refer the displacement of structure and CBI. In 1 (b), $m_{irb}, c_{irb}, k_{irb}$ refer the base mass, damping, and stiffness of the Inerter-BI, and m_{in} indicates the mass of the inerter. u_s and u_{irb} refer the displacement of structure and Inerter-BI. In 1 (c), m_{ib}, c_{ib}, k_{ib} refer the base mass, damping, and stiffness of the IABI. θ indicates the inertial angle between the y- axis and the rigid links when the isolated structure is in undeformed state. u_s and u_{ib} refer the of structure and IABI. m_s, c_s , and k_s refer the mass, damping, and stiffness of the main dynamic systems for all isolated systems presented in 1.

2.1. Structures isolated by classical base isolators

The responses of the structure isolated by inertial amplifier coupled base isolator are compared with the responses of structure isolated by classical base isolator. The structural parameters are contained similar and the damping and total mass ratios of both isolators are retained similar.

$$m_b \ddot{y}_b + c_b \dot{y}_b + k_b y_b - k_s y_s - c_s \dot{y}_s = -m_b \ddot{u}_g m_s \ddot{y}_s + c_s \dot{y}_s + k_s y_s = -m_s (\ddot{u}_g + \ddot{y}_b) \tag{1}$$

where, $y_b = u_b - u_g$ and $y_s = u_s - u_b$. $(\dot{\bullet})$ defines the derivative with respect to time. The isolated structure is subjected to a harmonic base motion. The relative displacement of the structure and the base isolator in Eq. (1) can be considered as $y_s = Y_s e^{i\omega t}$ and $y_b = Y_b e^{i\omega t}$. The function

of ground accelerations are considered as $u_g = U_g e^{i\omega t}$. In the displacement notations, $Y_s, Y_b,$ and U_g are the displacement amplitudes of the structure, base isolator, and the ground motion. After substituting the values in Eq. (1), the equation of motion can be expressed as:

$$\begin{aligned} q^2 m_b Y_b + q c_b Y_b + k_b Y_b - k_s Y_s - q c_s Y_s &= -q^2 m_b U_g \\ q^2 m_s Y_s + q^2 m_s Y_b + q c_s Y_s + k_s Y_s &= -q^2 m_s U_g \end{aligned} \tag{2}$$

where $q = i\omega$. The transfer function can be evaluated as:

$$\begin{bmatrix} A_{11} & A_{12} \\ A_{21} & A_{22} \end{bmatrix} \begin{Bmatrix} Y_s \\ Y_b \end{Bmatrix} = -q^2 \begin{bmatrix} 1 \\ \mu_b \end{bmatrix} U_g \tag{3}$$

$$\begin{aligned} A_{11} &= 2\zeta_s q\omega_s + q^2 + \omega_s^2; \\ A_{12} &= q^2; \\ A_{21} &= -2\zeta_s q\omega_s - \omega_s^2; \end{aligned} \tag{4}$$

$$A_{22} = \mu_b q^2 + 2\zeta_b q\omega_b (\mu_b + 1) + \omega_b^2 (\mu_b + 1)$$

Isolator parameters are considered as: isolator mass ratio to the structure $\mu_b = \frac{m_b}{m_s}$, damping ratio of the base isolator ζ_b which can be calculated from $\zeta_b = \frac{c_b}{2\omega_b M}, M = m_s + m_b, \epsilon_b = \left(\frac{\omega_b}{\omega_s}\right)^2$. The displacement responses of the structure and base isolator are obtained as:

$$H_s(q) = \frac{Y_s}{U_g} = \frac{-q^2 (\mu_b + 1) (2\zeta_b q\omega_b + \omega_b^2)}{\Delta_b} \tag{5}$$

$$H_b(q) = \frac{Y_b}{U_g} = \frac{-q^2 (2q\zeta_s \mu_b \omega_s + \mu_b q^2 + 2\zeta_s q\omega_s + \mu_b \omega_s^2 + \omega_s^2)}{\Delta_b} \tag{6}$$

$$\begin{aligned} \Delta_b &= 2\zeta_s \omega_s (\mu_b + 1) q^3 + (\omega_s^2 + \omega_b^2) (\mu_b + 1) q^2 \\ &+ 2\zeta_s \omega_s \omega_b^2 (\mu_b + 1) q + \omega_b^2 \omega_s^2 (\mu_b + 1) \\ &+ 2q\zeta_b (2\zeta_s q\omega_s + q^2 + \omega_s^2) (\mu_b + 1) \omega_b + q^4 \mu_b \end{aligned} \tag{7}$$

The shear force can be obtained as:

$$H_{sf}(q) = \frac{q\zeta_s Y_s + \omega_s^2 Y_s}{U_g} = \frac{(-q^2 (\mu_b + 1) (2\zeta_b q\omega_b + \omega_b^2) (q\zeta_s + \omega_s^2))}{\Delta_b} \tag{8}$$

The transfer matrix in Eq. (3) can be represented as fully non-dimensional manner and presented as:

$$\begin{bmatrix} \tilde{A}_{11} & \tilde{A}_{12} & \tilde{A}_{21} & \tilde{A}_{22} \end{bmatrix} \begin{Bmatrix} Y_s \\ Y_b \end{Bmatrix} = \eta^2 \begin{bmatrix} 1 \\ \mu_b \end{bmatrix} U_g \tag{9}$$

$$\tilde{A}_{11} = -\eta^2 + 2i\zeta_s \eta + 1; \tilde{A}_{12} = -\eta^2; \tilde{A}_{21} = -2i\zeta_s \eta - 1; \tilde{A}_{22} = -\mu_b \eta^2 + 2i\zeta_b \eta \sqrt{\epsilon_b} (\mu_b + 1) + \epsilon_b (\mu_b + 1) \tag{10}$$

The non-dimensional displacement responses are evaluated as:

$$H_s(\eta) = \frac{Y_s}{U_g} = \frac{-\eta^2 (2i\zeta_b \eta \sqrt{\epsilon_b} + \epsilon_b) (\mu_b + 1)}{\Delta_{b1}} \tag{11}$$

$$H_b(\eta) = \frac{Y_b}{U_g} = \frac{-\eta^2 (-\mu_b \eta^2 + \mu_b + 1 + i(2\eta\zeta_s \mu_b + 2\zeta_s \eta))}{\Delta_{b1}} \tag{12}$$

$$\begin{aligned} \Delta_{b1} &= 2(\mu_b + 1)\zeta_b (\eta^2 i + 2\zeta_s \eta - i) \eta \sqrt{\epsilon_b} - \eta^4 \mu_b + 2i\zeta_s (\mu_b + 1) \eta^3 \\ &+ (\epsilon_b + 1) (\mu_b + 1) \eta^2 - 2i\zeta_s (\mu_b + 1) \epsilon_b \eta - \epsilon_b (\mu_b + 1) \end{aligned} \tag{13}$$

where $\eta = \omega/\omega_s$.

2.2. Structures isolated by inerter-based isolation systems

In recent days, inerter based systems have been widely used for structural vibration control. The structure isolated by inerter-based isolation system is presented in 1 (b). The equations of motion of the structure isolated by inerter-based isolation system [41] are expressed as:

$$\begin{aligned} m_s \ddot{y}_s + (m_s + m_{irb} + m_{in}) \ddot{y}_{irb} + c_{irb} \dot{y}_{irb} + k_{irb} y_{irb} \\ = -(m_s + m_{irb}) \ddot{u}_g m_s \ddot{y}_s + c_s \dot{y}_s + k_s y_s = -m_s (\ddot{u}_g + \ddot{y}_{irb}) \end{aligned} \tag{14}$$

Above equations of motion can be written as:

$$\begin{aligned} (\ddot{y}_s + \ddot{y}_{irb}) + 2\zeta \omega_s \dot{y}_s + \omega_s^2 y_s = -\ddot{u}_g (\ddot{y}_s + \ddot{y}_{irb}) + \mu_{irb} \ddot{y}_{irb} + \kappa^2 \omega_s^2 y_{irb} + 2\xi \omega_s \dot{y}_{irb} \\ + \mu \ddot{y}_{irb} = -(1 + \mu_{irb}) \ddot{u}_g \end{aligned} \tag{15}$$

where mass ratio of base mass to structure: $\mu_{irb} = \frac{m_{irb}}{m_s}$, frequency of the structure: $\omega_s = \sqrt{\frac{k_s}{m_s}}$, viscous damping ratio of the structure: $\zeta = \frac{c_s}{2m_s \omega_s}$, frequency ratio of the inerter-bi to structure: $\kappa = \sqrt{\frac{k_{irb}}{m_s}}/\omega_s$, viscous damping ratio of the inerter-bi: $\xi = \frac{c_{irb}}{2\sqrt{k_s m_s}}$, mass ratio of inerter to structure: $\mu = \frac{m_{in}}{m_s}$. In Eq. (15), $y_{irb} = (u_{irb} - u_g)$, the relative displacement of the base mass with respect to ground and $y_s = (u_s - u_{irb})$, the relative displacement of structure with respect to base mass. It is considered that the isolated system is subjected to harmonic ground motions. The steady state solutions of the displacements of the dynamic system isolated by Inerter-BI under harmonic ground motions can be evaluated as: $y_s = Y_s e^{i\omega t}, y_{irb} = Y_{irb} e^{i\omega t}$. ($\dot{\bullet}$) defines the derivative with respect to time. The function of ground accelerations are considered as $u_g = U_g e^{i\omega t}$. The transfer function can be formed as:

$$\begin{bmatrix} V_{11} & V_{12} \\ V_{21} & V_{22} \end{bmatrix} \begin{Bmatrix} Y_s \\ Y_{irb} \end{Bmatrix} = -q^2 \begin{bmatrix} 1 \\ 1 + \mu_{irb} \end{bmatrix} U_g \tag{16}$$

$$\begin{aligned} V_{11} &= 2\zeta_s q\omega_s + q^2 + \omega_s^2; \\ V_{12} &= q^2; \\ V_{21} &= q^2; \end{aligned} \tag{17}$$

$$V_{22} = (1 + \mu + \mu_{irb}) q^2 + 2\xi q\omega_s + \kappa^2 \omega_s^2$$

where $q = i\omega$. The displacement responses of structure and Inerter-BI are evaluated as:

$$H_s(q) = \frac{Y_s}{U_g} = \frac{-q^2 (\kappa^2 \omega_s^2 + \mu q^2 + 2\xi q\omega_s)}{\Delta_{irb}} \tag{18}$$

$$H_{irb}(q) = \frac{Y_{irb}}{U_g} = \frac{-q^2 \left(\frac{2\zeta q \mu_{irb} \omega_s + 2\zeta q \omega_s}{+q^2 \mu_{irb} + \mu_{irb} \omega_s^2 + \omega_s^2} \right)}{\Delta_{irb}} \tag{19}$$

$$\begin{aligned} \Delta_{irb} &= (\mu + \mu_{irb}) q^4 + 2((1 + \mu + \mu_{irb}) \zeta + \xi) \omega_s q^3 + \kappa^2 \omega_s^4 \\ &+ \omega_s^2 (4\zeta \xi + \kappa^2 + \mu + \mu_{irb} + 1) q^2 + 2\omega_s^3 (\zeta \kappa^2 + \xi) q \end{aligned} \tag{20}$$

The shear force can be obtained as:

$$H_{sf}(q) = \frac{q\zeta Y_s + \omega_s^2 Y_s}{U_g} = \frac{(-q^2 (\kappa^2 \omega_s^2 + \mu q^2 + 2\xi q\omega_s) (q\zeta + \omega_s^2))}{\Delta_{irb}} \tag{21}$$

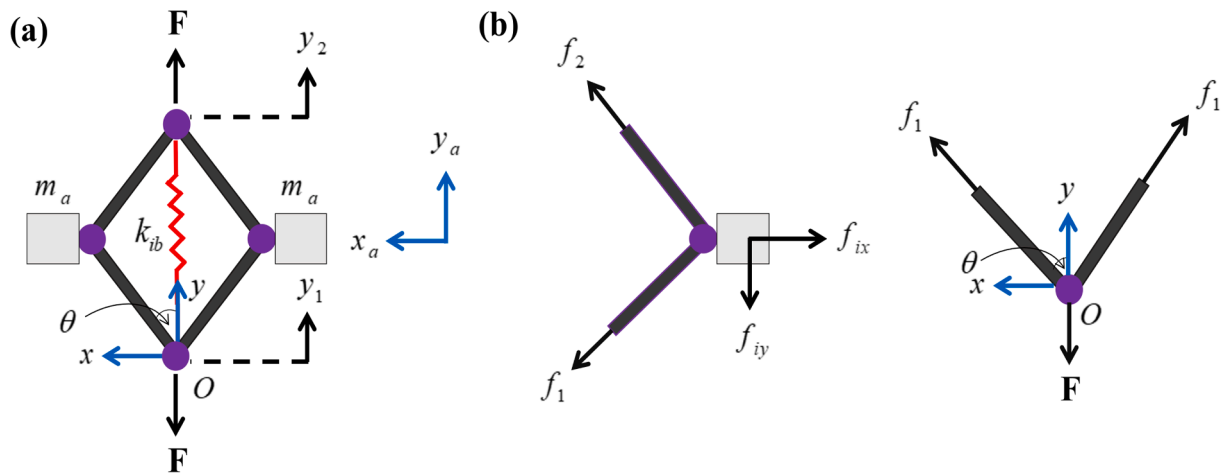

Fig. 2. (a) Schematic diagram of inertial amplifier (b) free-body diagram of inertial amplifier.

The displacement responses of the structure can also be evaluated in non-dimensional manner. To evaluate the dimensionless responses, Eq. (16) can be re-constructed as:

$$\begin{bmatrix} \tilde{V}_{11} & \tilde{V}_{12} & \tilde{V}_{21} & \tilde{V}_{22} \end{bmatrix} \begin{Bmatrix} Y_s \\ Y_{irb} \end{Bmatrix} = \eta^2 \begin{bmatrix} 1 \\ 1 + \mu_{irb} \end{bmatrix} U_g \quad (22)$$

$$\tilde{V}_{11} = -\eta^2 + 2i\zeta\eta + 1; \tilde{V}_{12} = -\eta^2; \tilde{V}_{21} = -\eta^2; \tilde{V}_{22} = -(1 + \mu + \mu_{irb})\eta^2 + 2i\zeta\eta + \kappa^2 \quad (23)$$

The displacement responses of the structure and Inerter-BI are evaluated as:

$$H_s(\eta) = \frac{Y_s}{U_g} = \frac{-\eta^2(-\eta^2\mu + \kappa^2 + 2i\zeta\eta)}{\Delta_{irb}} \quad (24)$$

$$H_{irb}(\eta) = \frac{Y_{irb}}{U_g} = \frac{-\eta^2(-\eta^2\mu_{irb} + \mu_{irb} + 1 + 2i\zeta\eta(1 + \mu_{irb}))}{\Delta_{irb}} \quad (25)$$

$$\Delta_{irb} = -\eta^4\mu - \eta^4\mu_{irb} + 4\zeta\eta^2\xi + \eta^2\kappa^2 + \eta^2\mu + \eta^2\mu_{irb} + \eta^2 - \kappa^2 + 2i((\mu + \mu_{irb} + 1)\zeta + \xi)\eta^2 - \zeta\kappa^2 - \xi\eta \quad (26)$$

2.3. Structures isolated by inertial amplifier coupled base isolators

The schematic diagram and free body diagrams of inertial amplifier are presented 2. An inertial angle θ between the y-axis and bars, is indicated in the diagrams when the inertial amplifier is in undeformed state. It is considered that the system moves towards the y-axis and small deflections occurred in lateral masses in x and y-directions. x_a and y_a indicate the displacement of lateral masses in x and y-directions, respectively. The values of the deflections can be evaluated as:

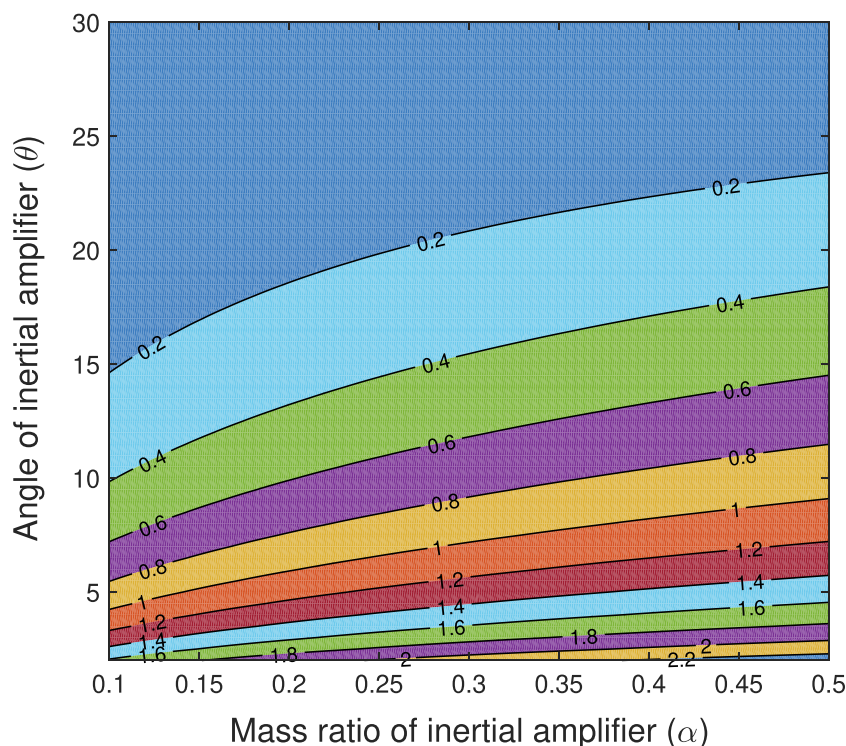

Fig. 3. Contours of \log_{10} of inertial amplification of IABI as a function of the inertial angle θ and mass ratio α .

$$y_a = \frac{y_1 + y_2}{2} \tag{27}$$

$$x_a = \pm \frac{y_2 - y_1}{2 \tan \theta} \tag{28}$$

It is assumed the total system is in equilibrium condition and inertial forces generated through the lateral masses can be evaluated as: $f_{ix} = m\ddot{x}_a$ and $f_{iy} = m\ddot{y}_a$. The internal forces through the rigid links are obtained as f_1 and f_2 and presented in 2 (b). The values of f_1 and f_2 can be evaluated as:

$$f_1 = \frac{1}{2} \left(\frac{f_{ix}}{\sin \theta} - \frac{f_{iy}}{\cos \theta} \right) \tag{29}$$

$$f_2 = \frac{1}{2} \left(\frac{f_{ix}}{\sin \theta} + \frac{f_{iy}}{\cos \theta} \right) \tag{30}$$

The total reaction forces through the system presented in 2 can be evaluated as:

$$F = -2f_1 \cos \theta + k_{ib}(y_2 - y_1) = d_1(\ddot{y}_2 - \ddot{y}_1) + d_2(\ddot{y}_2 + \ddot{y}_1) + k_{ib}(y_2 - y_1) \tag{31}$$

in which $d_1 = \frac{0.5m_a}{\tan^2 \theta}$ and $d_2 = 0.5m_a$ are the constants produced through the balancing of the inertial forces generated in the inertial amplifier which is presented in 2 (a). In the lateral masses, the total inertial forces are proportional to the mean of accelerations $\left(\frac{\ddot{y}_2 + \ddot{y}_1}{2}\right)$ generated through the two terminals of the inertial amplifier and the inertial constant d_2 is produced through that. d_1 constant produced by the inertial forces generated in the geometry of the inertial amplifier and the lateral masses of the entire system. It is observed that the inertial forces of the entire system is directly proportional to the relative acceleration $\left(\frac{\ddot{y}_2 - \ddot{y}_1}{2}\right)$ between two terminals. The equations of motion of the structure isolated by inertial amplifier coupled base isolator in 1 (c) can be obtained as:

$$m_{ia}\ddot{y}_{ib} + c_{ib}\dot{y}_{ib} + k_{ib}y_{ib} - k_s y_s - c_s \dot{y}_s = -m_{ia}\ddot{u}_g m_s \ddot{y}_s + m_s \ddot{y}_{ib} + c_s \dot{y}_s + k_s y_s = -m_s \ddot{u}_g \tag{32}$$

In Eq. (32), the total effective mass of the IABI is evaluated as: $m_{ia} = m_{ib} + 0.5m_a \left(1 + \frac{1}{\tan^2 \theta}\right)$. Now, inertial amplification need to be evaluated and can be determined as:

$$\alpha = \frac{m_a}{m_{ib} + 2m_a}; m_a = \left(\frac{\alpha}{(1 - 2\alpha)}\right) m_{ib} \tag{33}$$

$$\beta = \frac{m_{ib}}{m_{ib} + 2m_a} = (1 - 2\alpha) \tag{34}$$

$$\Lambda_f = \frac{m_{ib}}{m_{ib} + 2m_a} + \frac{0.5m_a}{m_{ib} + 2m_a} \left(1 + \frac{1}{\tan^2 \theta}\right) = (1 - 1.5\alpha) + \left(\frac{0.5\alpha}{\tan^2 \theta}\right) \tag{35}$$

In Eq. (33), Eq. (34), and Eq. (35), $\alpha, \beta,$ and Λ_f refer the mass ratios of inertial amplifier, base mass, and effective mass to the total static mass of the IABI. The inertial amplification of IABI system is presented in 3. In 3, more inertial amplification occurs at the lower angle and higher mass ratio of the inertial amplifier to total static mass α . To get inertial amplification through the increment of dynamic mass, $\alpha < 0.5$. At $\alpha = 0.5$, the effective mass ratio $\Lambda_f = 0$ and $\alpha > 0.5$, the effective mass ratio Λ_f becomes $-ve$. In Eq. (32), the relative displacement of base with respect to ground: $y_{ib} = (u_{ib} - u_g)$, and the relative displacement of structure with respect to base mass: $y_s = (u_s - u_{ib})$. It is considered that the isolated system is subjected to harmonic ground motions. The steady state solutions of the displacements of the dynamic system isolated by IABI under harmonic ground motions can be evaluated as: $y_s = Y_s e^{i\omega t}$,

$y_{ib} = Y_{ib} e^{i\omega t}$. $(\dot{\bullet})$ defines the derivative with respect to time. The function of ground accelerations are considered as $u_g = U_g e^{i\omega t}$. The displacement of the structure and IABI can be obtained by deriving the solutions analytically. After substituting the steady state solutions in Eq. (32), the transfer matrix can be formed. From where the responses can be evaluated easily and the transfer matrix of the above equations motion can be presented as:

$$\begin{bmatrix} B_{11} & B_{12} \\ B_{21} & B_{22} \end{bmatrix} \begin{Bmatrix} Y_s \\ Y_{ib} \end{Bmatrix} = -q^2 \begin{bmatrix} 1 \\ \mu_{ia} \end{bmatrix} U_g \tag{36}$$

$$\begin{aligned} B_{11} &= 2\zeta_s q \omega_s + q^2 + \omega_s^2; \\ B_{12} &= q^2; \\ B_{21} &= -2\zeta_s q \omega_s - \omega_s^2; \\ B_{22} &= 2\zeta_{ib} q \omega_{ib} \mu_{ia} + \mu_{ia} q^2 + \omega_{ib}^2 \mu_{ia} \end{aligned} \tag{37}$$

where $q = i\omega$. The displacement responses of structure and IABI are evaluated as:

$$H_s(q) = \frac{Y_s}{U_g} = \frac{-q^2 \mu_{ia} \omega_{ib} (2\zeta_{ib} q + \omega_{ib})}{\Delta_{ia}} \tag{38}$$

$$H_{ib}(q) = \frac{Y_{ib}}{U_g} = \frac{-q^2 (2q\zeta_s \mu_{ia} \omega_s + \mu_{ia} q^2 + 2\zeta_s q \omega_s + \mu_{ia} \omega_s^2 + \omega_s^2)}{\Delta_{ia}} \tag{39}$$

$$\begin{aligned} \Delta_{ia} &= q^4 \mu_{ia} + ((2\zeta_{ib} \omega_{ib} + 2\zeta_s \omega_s) \mu_{ia} + 2\zeta_s \omega_s) q^3 \\ &+ ((4\zeta_{ib} \zeta_s \omega_{ib} \omega_s + \omega_{ib}^2 + \omega_s^2) \mu_{ia} + \omega_s^2) q^2 \\ &+ 2\mu_{ia} \omega_s \omega_{ib} (\zeta_{ib} \omega_s + \zeta_s \omega_{ib}) q + \mu_{ia} \omega_{ib}^2 \omega_s^2 \end{aligned} \tag{40}$$

The shear force can be obtained as:

$$H_{sf}(q) = \frac{q\zeta_s Y_s + \omega_s^2 Y_s}{U_g} = \frac{(-q^2 \mu_{ia} \omega_{ib} (2\zeta_{ib} q + \omega_{ib}) (q\zeta_s + \omega_s^2))}{\Delta_{ia}} \tag{41}$$

The displacement responses of the structure can also be evaluated in non-dimensional manner. To evaluate the dimensionless responses, Eq. (36) can be re-constructed as:

$$\begin{bmatrix} \tilde{B}_{11} & \tilde{B}_{12} & \tilde{B}_{21} & \tilde{B}_{22} \end{bmatrix} \begin{Bmatrix} Y_s \\ Y_{ib} \end{Bmatrix} = \eta^2 \begin{bmatrix} 1 \\ \mu_{ia} \end{bmatrix} U_g \tag{42}$$

$$\begin{aligned} \tilde{B}_{11} &= -\eta^2 + 2i\zeta_s \eta + 1; \tilde{B}_{12} = -\eta^2; \tilde{B}_{21} = -2i\zeta_s \eta - 1; \tilde{B}_{22} = -\mu_{ia} \eta^2 \\ &+ 2i\zeta_{ib} \eta \mu_{ia} + \eta_{ib}^2 \mu_{ia} \end{aligned} \tag{43}$$

The displacement responses of the structure and IABI are evaluated as:

$$H_s(\eta) = \frac{Y_s}{U_g} = \frac{-\mu_{ia} \eta^2 \eta_{ib} (2i\zeta_{ib} \eta + \eta_{ib})}{\Delta_{ib}} \tag{44}$$

$$H_{ib}(\eta) = \frac{Y_{ib}}{U_g} = \frac{-\eta^2 (-\mu_{ia} \eta^2 + \mu_{ia} + 1 + 2i(\eta\zeta_s \mu_{ia} + \zeta_s \eta))}{\Delta_{ib}} \tag{45}$$

$$\begin{aligned} \Delta_{ib} &= (-\eta^4 + (4\zeta_{ib} \zeta_s \eta_{ib} + \eta_{ib}^2 + 1) \eta^2 - \eta_{ib}^2) \mu_{ia} + \eta^2 \\ &+ 2i\eta ((\eta_{ib} \zeta_{ib} + \zeta_s) \eta^2 - \zeta_s \eta_{ib}^2 - \eta_{ib} \zeta_{ib}) \mu_{ia} + \eta^2 \zeta_s \end{aligned} \tag{46}$$

where frequency ratio of harmonic ground motions to structure: $\eta = \frac{\omega}{\omega_s}$, mass ratio of IABI to structure: $\mu_{ia} = \frac{m_{ia}}{m_s}$, frequency ratio of IABI to structure: $\eta_{ib} = \frac{\omega_{ib}}{\omega_s}$, viscous damping ratio of IABI: $\zeta_{ib} = \frac{c_{ib}}{2m_{ia}\omega_{ib}}$, and viscous damping ratios of the structure: $\zeta_s = \frac{c_s}{2m_s\omega_s}$, frequency of the structure: $\omega_s = \sqrt{\frac{k_s}{m_s}}$, frequency of the IABI: $\omega_{ib} = \sqrt{\frac{k_{ib}}{m_{ia}}}$.

3. Stochastic response evaluation

To evaluate the stochastic responses, it is considered that the isolated

structures in 1 are subjected to Gaussian White Noise. It is also noted that all the isolated structures are linear vibratory system and the general form of the equations of motion Eq. (1), Eq. (14) and Eq. (32) can be written as:

$$M\ddot{y}(t) + C\dot{y}(t) + Ky(t) = -F_b(t) \tag{47}$$

$F_b(t)$ represents the forcing vector which is different for each isolated structure and presented as: $[m_s, m_b]^T \ddot{u}_g(t)$ for structure isolated by CBI, $[m_s, (m_s + m_{irb})]^T \ddot{u}_g(t)$ for structure isolated by Inerter-BI, and $[m_s, m_{ia}]^T \ddot{u}_g(t)$ for structure isolated by IABI. Each force acting to the corresponding degree of freedom. The general form of the forcing function can be represented as:

$$F_b \begin{pmatrix} t \\ t \\ \dots \\ t \end{pmatrix} = \begin{pmatrix} f_{b1}(t) \\ f_{b2}(t) \\ \dots \\ f_{bn}(t) \end{pmatrix} \tag{48}$$

Each component of force $f_{bi}(t)$ is assumed as randomly correlated. The power spectral density matrix can be formed as:

$$S_{F_b F_b}(\omega) = E[F_b(\omega) F_b(\omega)^*] = \begin{bmatrix} S_{f_{b1}f_{b1}}(\omega) & S_{f_{b1}f_{b2}}(\omega) & \dots & S_{f_{b1}f_{bn}}(\omega) \\ S_{f_{b2}f_{b1}}(\omega) & S_{f_{b2}f_{b2}}(\omega) & \dots & S_{f_{b2}f_{bn}}(\omega) \\ \dots & \dots & \dots & \dots \\ S_{f_{bn}f_{b1}}(\omega) & S_{f_{bn}f_{b2}}(\omega) & \dots & S_{f_{bn}f_{bn}}(\omega) \end{bmatrix} \tag{49}$$

In Eq. (49), the off-diagonal values are indicated as cross power spectral density functions and the diagonal values are indicated as auto power spectral density functions. After substituting $\ddot{u}_g(t) = U_g e^{i\omega t}$ in $F_b(t)$, the loading function can be represented in frequency domain and presented as: $F_b(t) = F_b(\omega) e^{i\omega t}$. In Eq. (47), $y(t)$ refers the displacement vectors containing the relative displacement of the main structure $y_s(t)$ and each isolator (i.e. $y_b(t)$ for CBI, $y_{irb}(t)$ for Inerter-BI, $y_{ib}(t)$ for IABI), respectively. Thus, the displacement vectors for each isolated system are represented as: $[y_s, y_b]^T$ for structure isolated by CBI, $[y_s, y_{irb}]^T$ for structure isolated by Inerter-BI, and $[y_s, y_{ib}]^T$ for structure isolated by IABI. The generalized form of the displacement response vectors can be converted to frequency domain by assuming $y(t) = Y(\omega) e^{i\omega t}$, where $Y(\omega)$ is the displacement amplitude vectors of the isolated structures. After substituting the values of $y(t)$ and $F_b(t)$ in Eq. (47), the equations of motions are converted to frequency domain and presented as:

$$(q^2 M + qC + K)Y(\omega) = -F_b(\omega); U(\omega)Y(\omega) = -F_b(\omega); Y(\omega) = H(\omega)F_b(\omega) \tag{50}$$

The matrix of power spectral density containing the vector $y(t)$ is obtained as:

$$S_{yy}(\omega) = E[Y(\omega)Y(\omega)^*] = H(\omega)S_{F_b F_b}(\omega)H(\omega)^* \tag{51}$$

The Gaussian White Noise have zero mean and standard deviation 2. The standard deviation of the displacement response has derived by using the dimensional terms to implement the formula below:

$$\sigma_{y_s}^2 = E\left[\dot{y}_s^2(t)\right] = R_{yy}(\dot{0}) = \int_{-\infty}^{\infty} |H(\omega)|^2 S_{F_b F_b}(\omega) d\omega \tag{52}$$

In the frequency domain, the velocity of the structure can be expressed as

$$\dot{Y}_s(\omega) = (i\omega)Y_s(\omega) = (i\omega)H_s(\omega)F_b(\omega) \tag{53}$$

Since $\dot{y}_s(t)$ is also a zero-mean stationary Gaussian random process, its standard deviation can be obtained in a similar manner as

$$\sigma_{\dot{y}_s}^2 = E\left[\dot{y}_s^2(t)\right] = \int_{-\infty}^{\infty} \left\{ (i\omega)H(\omega) \right\} \left\{ (i\omega)H(\omega) \right\}^* S_{F_b F_b}(\omega) d\omega = \int_{-\infty}^{\infty} \omega^2 |H_s(\omega)|^2 S_{F_b F_b}(\omega) d\omega \tag{54}$$

The expressions of σ_{y_s} and $\sigma_{\dot{y}_s}$ are then substituted into the expressions derived in the previous subsections. The calculation of the integral on the right-hand side of equations Eq. (52) and Eq. (54) in general requires the calculation of integrals involving the ratio of polynomials of the following form

$$I_n = \int_{-\infty}^{\infty} \frac{\Xi_n(\omega) d\omega}{\Lambda_n(i\omega)\Lambda_n^*(i\omega)} \tag{55}$$

(•)* complex conjugate. Here the polynomials are expressed as

$$\Xi_n(\omega) = b_{n-1}\omega^{2n-2} + b_{n-2}\omega^{2n-4} + \dots + b_0 \tag{56}$$

$$\Lambda_n(i\omega) = a_n(i\omega)^n + a_{n-1}(i\omega)^{n-1} + \dots + a_0 \tag{57}$$

Following Roberts and Spanos [69] this integral can be evaluated as

$$I_n = \frac{\pi \det[\mathbf{N}_n]}{a_n \det[\mathbf{D}_n]} \tag{58}$$

Here the $n \times n$ matrices are defined as

$$\mathbf{N}_n = \begin{bmatrix} b_{n-1} & b_{n-2} & \dots & b_0 \\ -a_n & a_{n-2} & -a_{n-4} & a_{n-6} & \dots & 0 & \dots \\ 0 & -a_{n-1} & a_{n-3} & -a_{n-5} & \dots & 0 & \dots \\ 0 & a_n & -a_{n-2} & a_{n-4} & \dots & 0 & \dots \\ 0 & \dots & \dots & \dots & \dots & 0 & \dots \\ 0 & 0 & \dots & \dots & \dots & -a_2 & a_0 \end{bmatrix} \tag{59}$$

and

$$\mathbf{D}_n = \begin{bmatrix} a_{n-1} & -a_{n-3} & a_{n-5} & -a_{n-7} & \dots & 0 & \dots \\ -a_n & a_{n-2} & -a_{n-4} & a_{n-6} & \dots & 0 & \dots \\ 0 & -a_{n-1} & a_{n-3} & -a_{n-5} & \dots & 0 & \dots \\ 0 & a_n & -a_{n-2} & a_{n-4} & \dots & 0 & \dots \\ 0 & \dots & \dots & \dots & \dots & 0 & \dots \\ 0 & 0 & \dots & \dots & \dots & -a_2 & a_0 \end{bmatrix} \tag{60}$$

These expressions will be used for the two cases considered. We assume that the excitation \ddot{u}_g is Gaussian white noise so that its spectral density is constant with respect to frequency. But different spectral densities can be easily used within the scope of this formulation.

3.1. Peak statistics for structure with inertial amplifier coupled base isolator

Since the forcing function has constant spectral density we assume that

$$S_{F_b F_b}(\omega) = S_0 \tag{61}$$

As the input spectrum is considered as white, thus S_0 refers a constant for all frequencies. Therefore, the standard deviation of $y_s(t)$ can be obtained using equation Eq. (52) as

$$\sigma_{y_s}^2 = \int_{-\infty}^{\infty} |H(\omega)|^2 S_0 d\omega = S_0 \int_{-\infty}^{\infty} \frac{\omega^2}{\Delta_1(i\omega)\Delta_1^*(i\omega)} d\omega \tag{62}$$

The standard deviation of the derivative of the voltage $\dot{y}_s(t)$ can be obtained using equation Eq. (54) as

$$\sigma_{\dot{y}_s}^2 = \int_{-\infty}^{\infty} \omega^2 |H(\omega)|^2 S_0 d\omega = S_0 \int_{-\infty}^{\infty} \frac{\omega^4}{\Delta_1(i\omega)\Delta_1^*(i\omega)} d\omega \tag{63}$$

The shear force of the structure due to the effect of random ground motions can be evaluated as:

$$\sigma_{sf}^2 = \int_{-\infty}^{\infty} |H_{sf}(\omega)|^2 S_0 d\omega \tag{64}$$

It can be found from the Eq. (65) that it is a 4th order polynomial equation.

$$\begin{aligned} \Delta_{ia} = & q^4 \mu_{ia} + ((2\zeta_{ib}\omega_{ib} + 2\zeta_s\omega_s)\mu_{ia} + 2\zeta_s\omega_s)q^3 \\ & + ((4\zeta_{ib}\zeta_s\omega_{ib}\omega_s + \omega_{ib}^2 + \omega_s^2)\mu_{ia} + \omega_s^2)q^2 \\ & + 2\mu_{ia}\omega_s\omega_{ib}(\zeta_{ib}\omega_s + \zeta_s\omega_{ib})q + \mu_{ia}\omega_{ib}^2\omega_s^2 \end{aligned} \tag{65}$$

where $q = i\omega$. The solution is derived below:

$$\begin{aligned} n = 4, b_0 = 0, b_1 = 0, b_2 = 1, b_3 = 0, a_0 = \mu_{ia}\omega_{ib}^2\omega_s^2, \\ a_1 = 2\mu_{ia}\omega_s\omega_{ib}(\zeta_{ib}\omega_s + \zeta_s\omega_{ib}), \\ a_2 = (4\zeta_{ib}\zeta_s\omega_{ib}\omega_s + \omega_{ib}^2 + \omega_s^2)\mu_{ia} + \omega_s^2, \\ a_3 = (2\zeta_{ib}\omega_{ib} + 2\zeta_s\omega_s)\mu_{ia} + 2\zeta_s\omega_s, a_4 = \mu_{ia} \end{aligned} \tag{66}$$

Now using Eq. (55), the integral can be evaluated as

$$\int_{-\infty}^{\infty} \frac{\omega^2}{\Delta(i\omega)\Delta^*(i\omega)} d\omega = \frac{\pi}{a_4} \frac{\det \begin{bmatrix} b_3 & b_2 & b_1 & 0 \\ -a_4 & a_2 & -a_0 & 0 \\ 0 & -a_3 & a_1 & 0 \\ 0 & -a_4 & a_2 & a_0 \end{bmatrix}}{\det \begin{bmatrix} a_3 & -a_1 & 0 & 0 \\ -a_4 & a_2 & -a_0 & 0 \\ 0 & -a_3 & a_1 & 0 \\ 0 & -a_4 & a_2 & a_0 \end{bmatrix}} \tag{67}$$

The standard deviation of the displacement response due to white represented as:

$$\sigma_{ys}^2 = \frac{S_0\pi(\zeta_{ib}\omega_s + \zeta_s\omega_{ib})}{\left(\begin{aligned} & 8\zeta_{ib}^2\zeta_s\mu_{ia}^2\omega_{ib}^2\omega_s^2 + 8\omega_{ib}\mu_{ia}\omega_s((0.25 + (\mu_{ia} + 1)\zeta_s^2)\omega_s^2 + \mu_{ia}\zeta_s^2\omega_{ib}^2)\zeta_{ib}^2 \\ & + 8\zeta_s(0.25(\mu_{ia} + 1)^2\omega_s^4 + \omega_{ib}^2((\mu_{ia} + 1)\zeta_s^2 - 0.5\mu_{ia})\mu_{ia}\omega_s^2 + 0.25\mu_{ia}^2\omega_{ib}^4)\zeta_{ib} \\ & + 2\zeta_s^2\mu_{ia}\omega_{ib}^3\omega_s \end{aligned} \right)} \tag{68}$$

The standard deviation in velocity responses are derived as:

$$\sigma_{ys}^2 = \frac{S_04\pi((\zeta_s^2\zeta_{ib}\omega_s\omega_{ib}^2 + \zeta_s\zeta_{ib}^2\omega_s^2\omega_{ib} + 0.25\zeta_s\omega_{ib}^3 + 0.25\zeta_{ib}\omega_s^3)\mu_{ia} + 0.25\zeta_{ib}\omega_s^3)}{8\mu_{ia} \left(\begin{aligned} & \zeta_s\zeta_{ib} \left(\zeta_{ib}^2\omega_s^2\omega_{ib}^2 + \zeta_s\omega_s\omega_{ib}(\omega_{ib}^2 + \omega_s^2)\zeta_{ib} \right) \mu_{ia}^2 \\ & + \left(\omega_s^2\omega_{ib}(0.25 + \zeta_s^2)\zeta_{ib}^2 + 0.25\zeta_s^2\omega_{ib}^3 \right) \omega_s\mu_{ia} + 0.25\zeta_s\zeta_{ib}\omega_{ib}^4 \end{aligned} \right)} \tag{69}$$

The standard deviation values for the shear force can be evaluated in similar manner. Now considered, $\zeta_s = 0$, and the mean square values are evaluated as:

$$\sigma_{ys}^2 = \frac{S_0\pi}{2\zeta_{ib}\omega_s^2\omega_{ib}\mu_{ia}} = \frac{S_0\pi}{2\omega_s^3\zeta_{ib}\eta_{ib}\mu_{ia}} \tag{70}$$

Table 1
Details of system parameters of uncontrolled and controlled structures.

Description	Symbol			Value
	CBI	Inerter-BI	IABI	
Structural damping ratio	ζ_s	ζ	ζ_s	0.01
Isolator damping ratio	ζ_b	ξ	ζ_{ib}	0.05
Frequency ratio of isolator to structure	ϵ_b	κ	η_{ib}	0.20
Total mass ratio of isolator to structure	μ_b	$\mu_{ib} + \mu$	$\mu_{ib} + 2\mu_a$	0.6
mass ratio of base mass to structure	...	μ_{ib}	μ_{ib}	0.4
mass ratio of inerter to structure	...	μ	...	0.2
mass ratio of lateral mass to structure	μ_a	0.1
Inertial angle	θ	30°

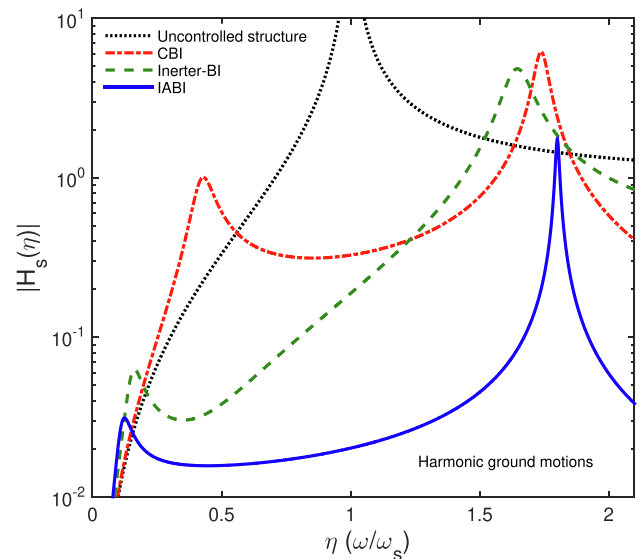

Fig. 4. (a) Variations of displacement amplitudes of structures with frequency ratios.

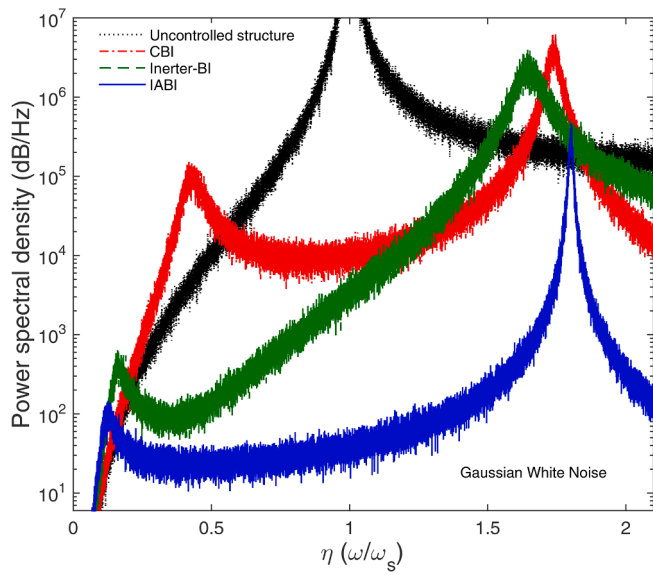

Fig. 5. Variations of power spectral density of the structures with frequency ratios.

$$\sigma_{\dot{y}_s}^2 = \frac{(\mu_{ia} + 1)S_0\pi}{2\zeta_{ib}\mu_{ia}^2\omega_{ib}} = \frac{(\mu_{ia} + 1)S_0\pi}{2\omega_s\zeta_{ib}\mu_{ia}^2\eta_{ib}} \quad (71)$$

Shear force can be evaluated as:

$$\sigma_{sf}^2 = \frac{S_0\pi(\omega_s^2 + \omega_{ib})}{8\omega_s^4\zeta_{ib}\Delta_{sf}} \quad (72)$$

$$\Delta_{sf} = \left(\begin{aligned} & \left(\frac{1}{4} + \frac{\mu_{ia}^2}{4} + \left(\frac{\omega_{ib}}{4} + \frac{1}{2} \right) \mu_{ia} \right) \omega_s^8 \\ & + \left(\left(\zeta_{ib}^2 - \frac{\omega_{ib}}{4} \right) \mu_{ia} + \zeta_{ib}^2 + \frac{\omega_{ib}}{4} \right) \mu_{ia} \omega_{ib} \omega_s^6 \\ & + \frac{(4\zeta_{ib}^4 + (-\omega_{ib} + 2)\zeta_{ib}^2 - \omega_{ib})\mu_{ia} + \zeta_{ib}^2}{4} \\ & + \zeta_{ib}^2 \mu_{ia}^2 \omega_{ib}^3 \left(\zeta_{ib}^2 - \frac{\omega_{ib}}{4} \right) \omega_s^2 + \frac{\zeta_{ib}^4 \mu_{ia}^2 \omega_{ib}^4}{4} \end{aligned} \right) \quad (73)$$

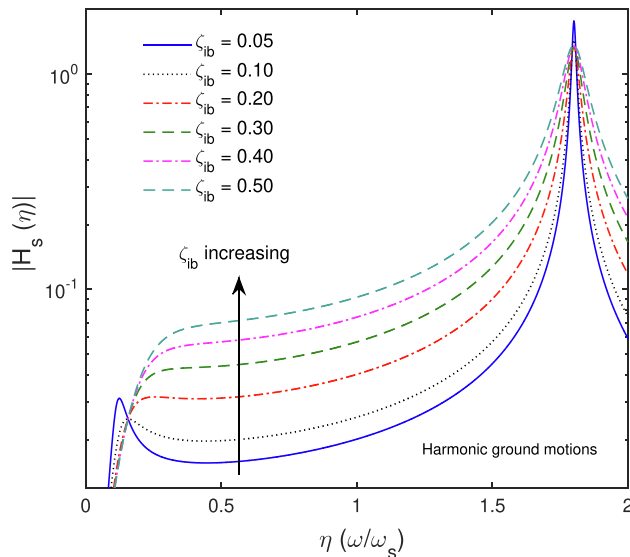

Fig. 6. Variations of displacement amplitudes of the structures isolated by IABI with frequency ratio for different value of ζ_{ib} , subjected to harmonic base excitation.

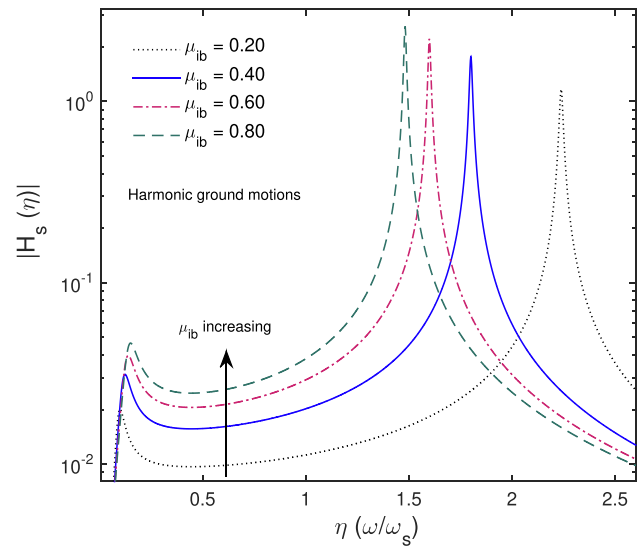

Fig. 7. Variations of displacement amplitudes of the structures isolated by IABI with frequency ratio for different value of μ_{ib} , subjected to harmonic base excitation.

It has observed that from Eq. (70) that the mass response of the structure is decreased by increasing the mass of the amplifier m_{ia} . Similar phenomena can also be observed damping ratio of the isolator ζ_{ib} . Here uncertainties in the base excitation is considered. There can be uncertainties in the model parameters also. Under certain assumptions, the response statistics of SDOF uncertain systems can be obtained analytically [70,71]. Future work will address the combined effect of model and base excitation uncertainties.

3.2. Comparison of stochastic responses of uncontrolled and controlled structures

The stochastic responses of uncontrolled and controlled structures are evaluated under Gaussian White Noise. The parameters of the main structures are considered exactly same and total mass ratios, viscous damping ratios, and frequency ratios are also considered exactly same.

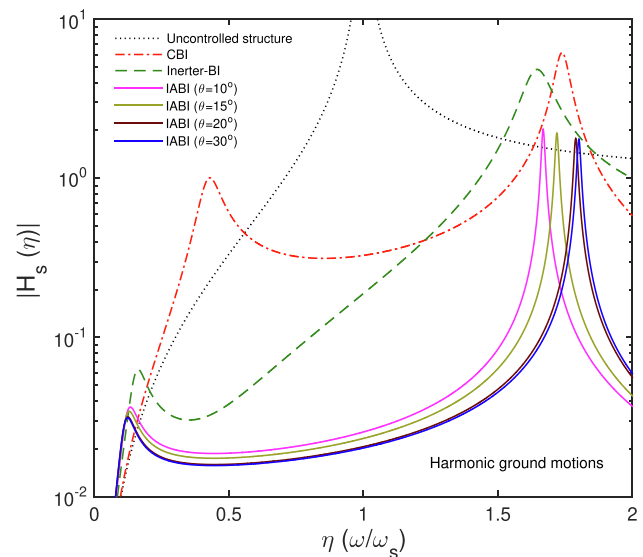

Fig. 8. Variations of displacement amplitudes of the structures isolated by IABI with frequency ratio for different value of θ , subjected to harmonic base excitation.

Table 2
Details of earthquake ground motions.

Earthquake	Year	M_w	Recording station	V_{s30} (m/s)	Component	E_s (km)	PGA _g
Northridge	1994	6.7	Beverly Hills – Mulhol	356	MUL009	13.3	0.52
Northridge	1994	6.7	Canyon Country-WLC	309	LOS270	26.5	0.48
Duzce, Turkey	1999	7.1	Bolu	326	BOL090	41.3	0.82
Hector Mine	1999	7.1	Hector	685	HEC000	26.5	0.34
Imperial Valley	1979	6.5	Delta	275	H-DLT352	33.7	0.35
Imperial Valley	1979	6.5	El Centro Array 11	196	H-EI1230	29.4	0.38
Kobe, Japan	1995	6.9	Nishi-Akashi	609	NIS090	8.7	0.51
Kobe, Japan	1995	7.5	Shin-Osaka	256	SHI000	46	0.24
Kocaeli, Turkey	1999	7.5	Duzce	276	DZC270	98.2	0.36
Kocaeli, Turkey	1999	7.3	Arcelik	523	ARC000	53.7	0.22
Landers	1992	7.3	Yermo Fire Station	354	YER270	86	0.24
Landers	1992	7.3	Coolwater	271	CLW-TR	82.1	0.42
Loma Prieta	1989	6.9	Capitola	289	CAP090	9.8	0.53
Loma Prieta	1989	6.9	Gilroy Array 3	350	G03000	31.4	0.56
Manjil, Iran	1990	7.4	Abbar	724	ABBAR-T	40.4	0.51
Superstition Hills	1987	6.5	El Centro Imp. Co.	192	B-ICC090	35.8	0.36
Superstition Hills	1987	6.5	Poe Road (temp)	208	B-POE270	11.2	0.45
Cape Mendocino	1992	7.0	Rio Dell Overpass	312	RIO270	22.7	0.55
Chi-Chi, Taiwan	1999	7.6	CHY101	259	CHY101-N	32	0.44
Chi-Chi, Taiwan	1999	7.6	TCU045	705	TCU045-N	77.5	0.51
San Fernando	1971	6.6	LA - Hollywood Stor	316	PEL180	39.5	0.21
Friuli, Italy	1976	6.5	Tolmezzo	425	A-TMZ270	20.2	0.35

4. Stochastic and frequency domain responses

In this section, the seismic responses of controlled and uncontrolled structures subjected to harmonic and Gaussian White Noise are presented.

4.1. Comparison of seismic performance of CBI, Inerter-BI, and IABI under harmonic ground motions and Gaussian White Noise

It is also noted that the super-structural parameters for uncontrolled and controlled structures are considered exactly same. The cumulative masses of classical base isolator, inerter-based isolator, and inertial amplifier coupled base isolator are remained similar as to compare

between the seismic performance of the proposed isolation system and other conventional systems, respectively. Total system parameters of uncontrolled and controlled structures [41] are presented in 1. The dynamic response of isolated structures under harmonic ground motions are shown in 4. In 4(a), the displacement amplitudes of the uncontrolled structure, structure isolated by classical base isolation system, structure controlled by inerter-based isolation system, and structure with inertial amplifier coupled base isolator are compared. The peak non-dimensional displacement amplitudes of the structure isolated by CBI, Inerter-BI and IABI are evaluated as 6.17, 4.84 and 1.76. Thus, It is observed that the seismic performance of IABI system is significantly 71.47% and 63.60% superior to the CBI and Inerter-BI. The stochastic responses of the structure isolated by CBI and IABI are evaluated and

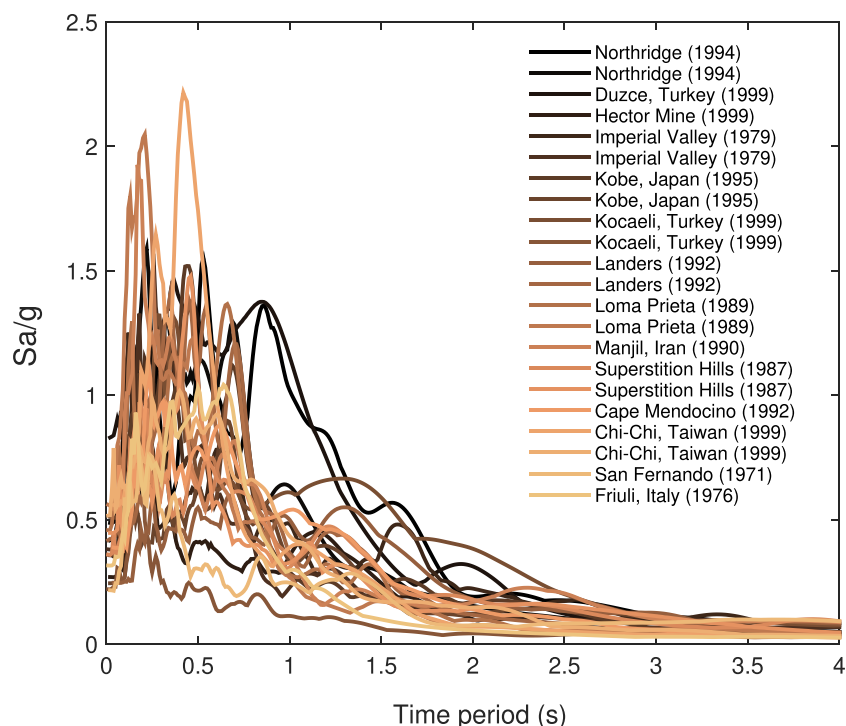

Fig. 9. Response spectra of the various earthquakes considered along with the designed spectra.

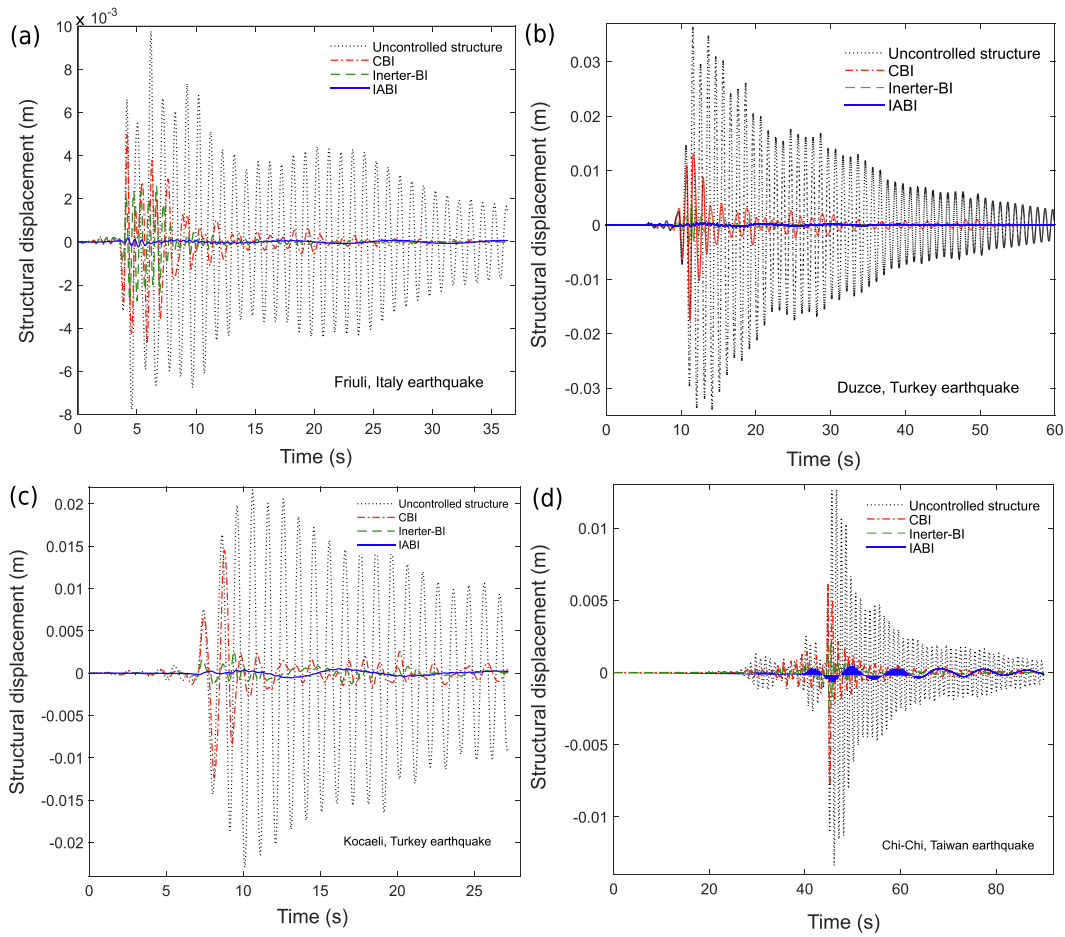

Fig. 10. Displacement history of the structures with time for different earthquake ground motion.

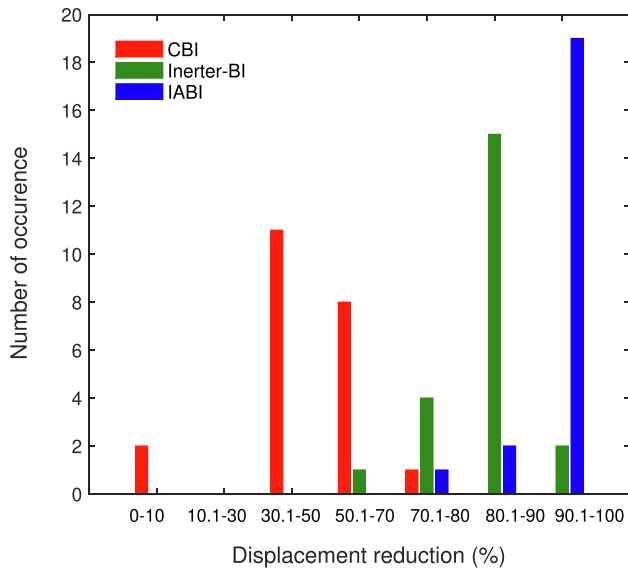

Fig. 11. Variation of number of occurrence with range of displacement reduction percentage.

Table 3

Displacement reduction (%) of structure with respect to uncontrolled structure under different earthquake ground motions.

Earthquake	Displacement reduction (%)		
	CBI	Inerter-BI	IABI
Northridge	61.86	92.33	99.04
Northridge	56.48	86.57	98.76
Duzce, Turkey	51.52	89.26	99.01
Hector Mine	38.71	91.13	94.77
Imperial Valley	63.11	86.89	94.66
Imperial Valley	47.15	83.74	94.27
Kobe, Japan	54.14	82.71	97.42
Kobe, Japan	43.59	87.82	98.72
Kocaeli, Turkey	41.13	79.84	88.71
Kocaeli, Turkey	42.55	72.34	74.47
Landers	47.03	89.73	92.43
Landers	4.23	63.38	83.10
Loma Prieta	70.51	83.87	99.19
Loma Prieta	63.64	84.09	97.99
Manjil, Iran	39.88	89.88	95.78
Superstition Hills	30.77	86.54	93.99
Superstition Hills	59.88	88.95	98.77
Cape Mendocino	5.94	73.27	95.36
Chi-Chi, Taiwan	45.92	84.12	90.56
Chi-Chi, Taiwan	54.17	81.55	96.35
San Fernando	41.33	87.78	96.73
Friuli, Italy	48.98	71.43	97.63
Mean	46.02	83.51	94.44
Standard Deviation	16.4297	7.3814	5.9500
Maximum	70.51	92.33	99.19
Minimum	4.23	63.38	74.47

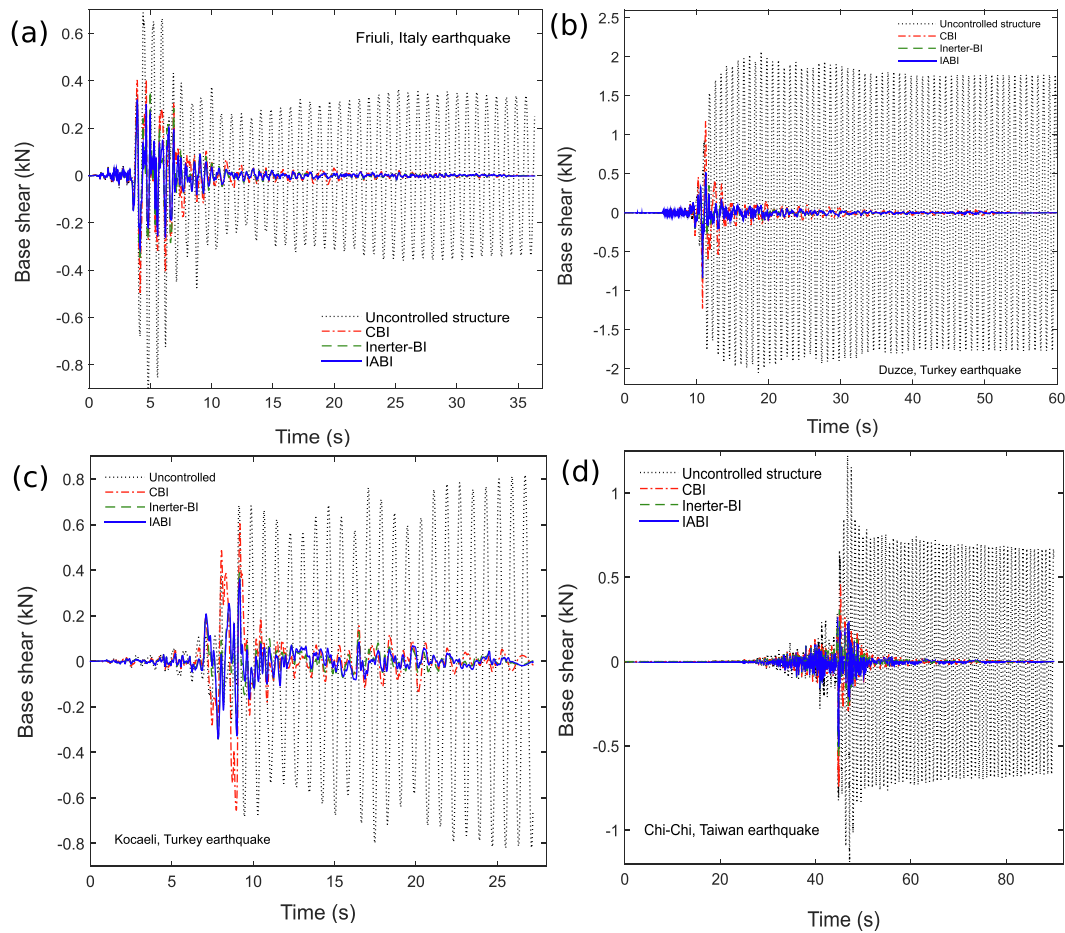

Fig. 12. (a–d) Variations of the base shear of the structure with time for different earthquakes.

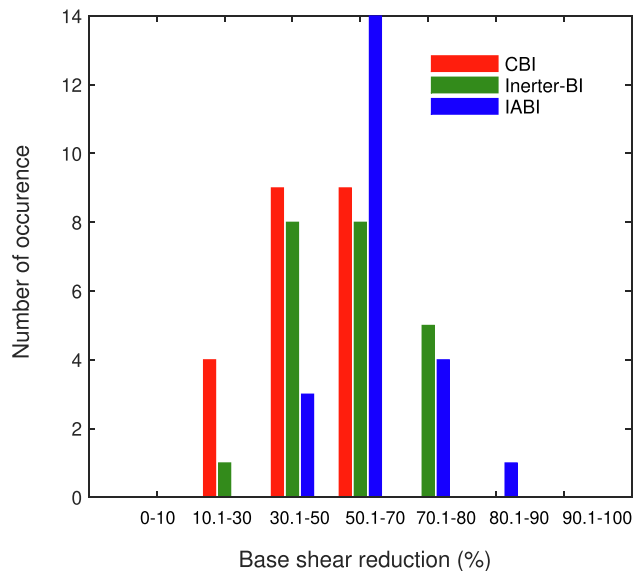

Fig. 13. Variation of number of occurrence with range of reduction percentage of the base shear.

Table 4

Base shear reduction (%) of controlled structure with respect to uncontrolled structure for different earthquakes.

Earthquake	Base shear reduction(%)		
	CBI	Inerter-BI	IABI
Northridge	57.07	76.13	78.73
Northridge	31.47	46.67	53.35
Duzce, Turkey	40.72	59.12	59.86
Hector Mine	56.93	71.01	72.50
Imperial Valley	63.31	72.95	74.37
Imperial Valley	36.51	61.18	63.09
Kobe, Japan	53.98	55.34	55.72
Kobe, Japan	54.12	74.54	74.97
Kocaeli, Turkey	40.19	63.08	64.38
Kocaeli, Turkey	30.88	45.92	47.29
Landers	63.68	77.13	82.44
Landers	16.70	38.18	43.40
Loma Prieta	54.15	63.96	66.40
Loma Prieta	12.82	29.92	37.97
Manjil, Iran	42.45	58.29	60.33
Superstition Hills	17.90	61.87	63.12
Superstition Hills	45.99	61.03	62.65
Cape Mendocino	36.09	46.05	56.94
Chi-Chi, Taiwan	54.19	66.90	68.86
Chi-Chi, Taiwan	38.74	56.58	58.95
San Fernando	25.75	49.26	53.06
Friuli, Italy	46.56	59.87	65.76
Mean	41.83	58.86	62.01
Standard Deviation	14.8780	12.3602	11.1150
Maximum	63.68	77.13	82.44
Minimum	12.82	29.92	37.97

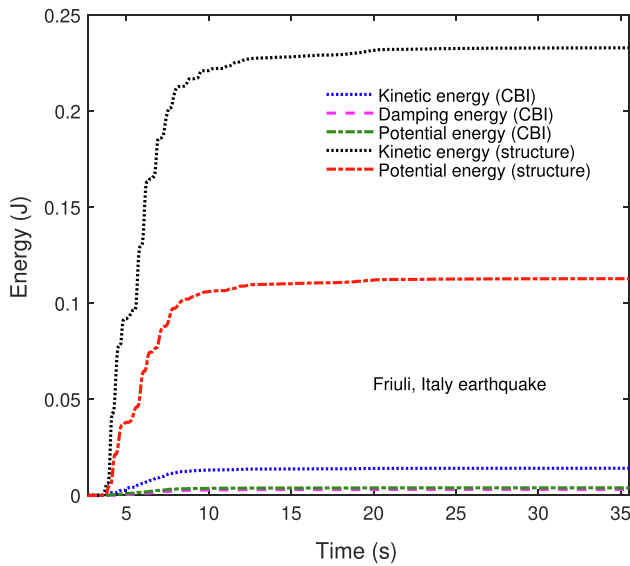

Fig. 14. (a) Energy plots of the structure isolated by classical base isolation system under Friuli, Italy earthquake.

presented in 5. As the uncontrolled and controlled structures are linear, it is expected that the stochastic response behaviour is also similar to the harmonic responses.

4.2. Sensitivity of system parameters of proposed IABI on the structural responses

The dynamic responses of structure isolated by proposed IABI under harmonic ground motions for different values of ζ_{ib} are presented in 6. It can be observed from 6 that for damping ratios less than 20% the peak displacement amplitude decreases, and it becomes pretty stable and approximately constant for higher damping values. The values of peak displacement amplitude of structure isolated by IABI are evaluated as 1.76, 1.44, 1.33, 1.34, 1.35, 1.36 for $0.05 < \zeta_{ib} < 0.50$. In 7, the displacement amplitudes of the structure isolated by IABIs for different values of the μ_{ib} are shown. The value of μ_{ib} are varied from 0.2 to 0.8. For the harmonic case, the peak values of the displacement amplitudes are as: 1.16, 1.76, 2.21, and 2.58. Similar type of results are observed for

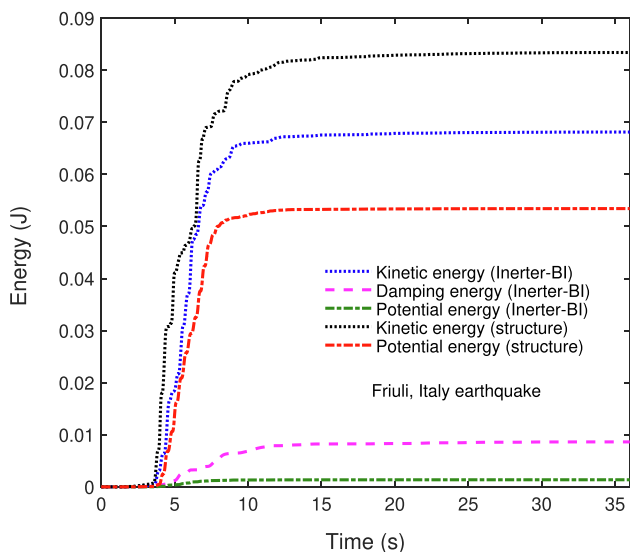

Fig. 15. (a) Energy plots of the structure isolated by inerter-based isolation system under Friuli, Italy earthquake.

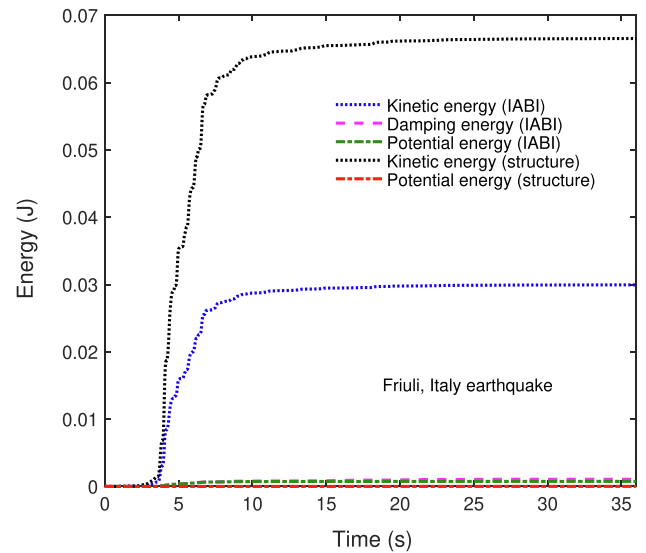

Fig. 16. (a) Energy plots of the structure isolated by inertial amplifier coupled base isolator under Friuli, Italy earthquake.

the random case. The seismic responses of the structures for different values of θ are presented in 8. The structural displacement amplitudes are obtained for four different values of inertial angle θ . 10° , 15° , 20° and 30° of the inertial angles are chosen to plot the results. For the harmonic case, the peak responses for adopted angles are 2.03, 1.92, 1.78, and 1.76. The stochastic response behaviour are also similar as all the systems are linear.

5. Time history analysis

The numerical study is conducted to evaluate the vibration reduction capacity of the proposed IABI. To perform the study, the time history plots of the uncontrolled and controlled structures are determined, and the structural responses of the controlled systems are compared with the structural responses of the uncontrolled structures. The masses of the structures (m_s) for uncontrolled and controlled structures are similar and considered as: 300 tons. Other structural and system parameters are already mentioned in the previous section. For the loading part, twenty-two real earthquake ground motions are implemented to perform these numerical study and the data of the earthquakes are downloaded from <https://peer.berkeley.edu/peer-strong-ground-motion-databases>. The details of the considered earthquakes are listed in 2. E_s defines the epicentral distance in km. The response spectra [72] at 5% damping for all the selected records have been plotted and presented in 9. The displacement histories of uncontrolled and controlled structures are presented in 10. The time history responses are evaluated for all twenty-two earthquakes but only for plots are presented as the nature of the plots are similar. In 11, statistical data of the displacement reduction (%) capacity of the proposed inertial amplifier coupled base isolator and classical base isolation is shown by histogram plot. This plot provides the exact seismic performance of the IABI and CBI systems. The peak relative displacement of the structure for all structural systems along with the response reduction(%) is listed in 3. It can be observed from the 3 and 10 that the response reduction capacity of the inertial amplifier coupled base isolator is better than CBI and Inerter-BI. The pattern of the displacement histogram plot is indicating as random distribution as it has several different peaks. The majority of the displacement reduction percentage for the IABI system wait between 80% to 100% while for the CBI system, the majority shows from 1% to 70%, and for Inerter-BI, from 70% to 80%. The time history plots of the base shear are evaluated and presented in 12(a-d) for similar earthquakes. IABI system performs significantly better than the CBI and Inerter-BI in terms of base shear

reduction. The histogram plot for the base shear reduction is indicating it as random distribution and shown in 13. The majority of the reduction in base shear waits between 1% to 50% for CBI, 1% to 70% for Inerter-BI, while for inertial amplifier coupled base isolator it waits between 30% to 90%. Base shear reductions(%) for all adopted earthquakes are presented in 4. The variations of kinetic energy, damping energy, and potential energy of structure and isolators are presented in 14, 15, and 16. The plots are proven the superior seismic performance of the proposed inertial amplifier coupled base isolator. The presented figures are evaluated due to the effect of Friuli, Italy earthquake ground motions. It is also seen that the nature of the energy plots for other earthquakes are similar.

6. Conclusions

A vibration base isolation system coupled with inertial amplifier has been proposed in the paper. An analytical solution has been developed to obtain the structural displacement of the amplified isolated system under harmonic ground motion. The frequency-domain results are also validated by the time history analysis. Standard deviation of the system response due to broadband random excitation has been obtained in closed-form. Twenty-two real earthquakes ground motions are implemented in the design to generate the earthquake responses. It can be concluded from the overall study that the seismic performance of the inertial amplifier coupled base isolator is significantly greater than the classical base isolation system. The proposed research can also be implemented in a practical scenario in the future. A fair comparison has been conducted between the inerter-based isolation system and inertial amplifier coupled base isolator to investigate the seismic performance and response reduction capacity, respectively. The key points of the proposed research are following:

- The underlying mechanics of the inertial amplifier coupled base isolator, introduced in this paper, is conceptually different from the well known flywheel-gear inerter [73] based base isolator.
- From the frequency domain results, it is observed that the seismic performance of proposed IABI system is 71.47% and 63.60% superior to the CBI and Inerter-BI. As all the systems are linear, the stochastic behaviour of the responses are similar to the responses evaluated under harmonic ground motions.
- It is also evidenced from the parametric study that with the help of smaller mass ratios of the inertial amplifier coupled base isolator to structure, the inertial angle between the stiffness spring and rigid link, and lower isolation damping, the proposed inertial isolation system mitigate the seismic responses most.
- It is also observed from the parametric study that for damping ratios less than 20% the peak displacement amplitude decreases, and it becomes pretty stable and approximately constant for higher damping values. The values of peak displacement amplitude of structure isolated by IABI are evaluated as 1.76, 1.44, 1.33, 1.34, 1.35, 1.36 for $0.05 < \zeta_{ib} < 0.50$.
- It is observed from the standard deviation solutions for structural displacement, acceleration and shear force of the structure that the favourable condition for the structural control achieved while the values of the effective mass of the inertial amplifier coupled base isolator (m_{ia}) and damping coefficient (ζ_{ib}) increases.
- From the numerical study, it is observed that the response reduction capacity of the IABI is 89.38% and 72% superior to the CBI and Inerter-BI.

The results implied that the proposed inertial amplifier coupled base isolator can be successfully implemented in vibration control of various structures. Future study will be conducted towards its experimentation and implementation in bridges and multi-storied buildings to mitigate the vibration responses.

Declaration of Competing Interest

The authors declare that they have no known competing financial interests or personal relationships that could have appeared to influence the work reported in this paper.

Acknowledgement

The authors' would like to acknowledge the Inspire faculty grant, Grant No. DST/INSPIRE/04/2018/000052 for partial financial support for the project.

References

- [1] Touaillon J. Improvement in buildings, U.S. Patent No. 99,973 (Feb. 15 1870).
- [2] Kazeminezhad E, Kazemi MT, Mirhosseini SM. Assessment of the vertical stiffness of elastomeric bearing due to displacement and rotation. *Int J Non-Linear Mech* 2020;119:103306.
- [3] Hwang J, Chiou J. An equivalent linear model of lead-rubber seismic isolation bearings. *Eng Struct* 1996;18(7):528–36.
- [4] Kelly JM. Base isolation: linear theory and design. *Earthq Spectra* 1990;6(2):223–44.
- [5] Makris N. Seismic isolation: early history. *Earthq Eng Struct Dyn* 2019;48(2):269–83.
- [6] De Luca A, Guidi LG. State of art in the worldwide evolution of base isolation design. *Soil Dyn Earthq Eng* 2019;125:105722.
- [7] Inaudi JA, Kelly JM. Optimum damping in linear isolation systems. *Earthq Eng Struct Dyn* 1993;22(7):583–98.
- [8] Adhikari S. Qualitative dynamic characteristics of a non-viscously damped oscillator. *Proc R Soc London Ser-A* 2005;461(2059):2269–2288.
- [9] Adhikari S, Pascual B. Eigenvalues of linear viscoelastic systems. *J Sound Vib* 2009;325(4–5):1000–11.
- [10] Batou A, Adhikari S. Optimal parameters of viscoelastic tuned-mass dampers. *J Sound Vib* 2019;445(4):17–28.
- [11] Lee DM. Base isolation for torsion reduction in asymmetric structures under earthquake loading. *Earthq Eng Struct Dyn* 1980;8(4):349–59.
- [12] Constantinou MC, Tadjbakhsh IG. Hysteretic dampers in base isolation: random approach. *J Struct Eng* 1985;111(4):705–21.
- [13] Eisenberger M, Rutenberg A. Seismic base isolation of asymmetric shear buildings. *Eng Struct* 1986;8(1):2–8.
- [14] Robinson WH. Lead-rubber hysteretic bearings suitable for protecting structures during earthquakes. *Earthq Eng Struct Dyn* 1982;10(4):593–604.
- [15] Buckle IG. New zealand seismic base isolation concepts and their application to nuclear engineering. *Nucl Eng Design* 1985;84(3):313–26.
- [16] Jangid R. Optimum friction pendulum system for near-fault motions. *Eng Struct* 2005;27(3):349–59.
- [17] Jangid R. Computational numerical models for seismic response of structures isolated by sliding systems. *Struct Control Health Monitor* 2005;12(1):117–37.
- [18] Shakib H, Fuladgar A. Response of pure-friction sliding structures to three components of earthquake excitation. *Comput Struct* 2003;81(4):189–96.
- [19] Castaldo P, Palazzo B, Ferrentino T. Seismic reliability-based ductility demand evaluation for inelastic base-isolated structures with friction pendulum devices. *Earthq Eng Struct Dyn* 2017;46(8):1245–66.
- [20] Castaldo P, Palazzo B, Alfano G, Palumbo MF. Seismic reliability-based ductility demand for hardening and softening structures isolated by friction pendulum bearings. *Struct Control Health Monit* 2018;25(11):e2256.
- [21] Pavese A, Furinghetti M, Casarotti C. Investigation of the consequences of mounting laying defects for curved surface slider devices under general seismic input. *J Earthq Eng* 2019;23(3):377–403.
- [22] Furinghetti M, Lanese I, Pavese A. Experimental assessment of the seismic response of a base-isolated building through a hybrid simulation. *Recent Advances and Applications of Seismic Isolation and Energy Dissipation Devices*.
- [23] Furinghetti M, Yang T, Calvi PM, Pavese A. Experimental evaluation of extra-stroke displacement capacity for curved surface slider devices. *Soil Dyn Earthq Eng* 2021;146:106752.
- [24] Eliseev S. Structural theory of vibration protection systems; 1978.
- [25] Rivin EL. Passive vibration isolation 2003.
- [26] Smith MC. Synthesis of mechanical networks: the inerter. *IEEE Trans Autom Control* 2002;47(10):1648–62.
- [27] Smith MC. The inerter: a retrospective. *Annu Rev Control Robot Autonomous Syst* 2020;3:361–91.
- [28] Smith MC, Wang F-C. Performance benefits in passive vehicle suspensions employing inerters. *Vehicle Syst Dyn* 2004;42(4):235–57.
- [29] Wang F-C, Liao M-K, Liao B-H, Su W-J, Chan H-A. The performance improvements of train suspension systems with mechanical networks employing inerters. *Veh Syst Dyn* 2009;47(7):805–30.
- [30] Wang F-C, Yu C-H, Chang M-L, Hsu M. The performance improvements of train suspension systems with inerters. In: *Proceedings of the 45th IEEE Conference on Decision and Control, IEEE*; 2006. p. 1472–7.
- [31] Wang F-C, Hsieh M-R, Chen H-J. Stability and performance analysis of a full-train system with inerters. *Veh Syst Dyn* 2012;50(4):545–71.

- [32] Hu Y, Chen MZ, Sun Y. Comfort-oriented vehicle suspension design with skyhook inerter configuration. *J Sound Vib* 2017;405:34–47.
- [33] Chen MZ, Hu Y. Inerter and its application in vibration control systems. Springer; 2019.
- [34] Kuhnert WM, Gonçalves PJP, Ledezma-Ramirez DF, Brennan MJ. Inerter-like devices used for vibration isolation: a historical perspective. *J Franklin Inst*.
- [35] Qian F, Luo Sr Y, Sun H, Tai WC, Zuo L. Performance enhancement of a base-isolation structure using optimal tuned inerter dampers. In *Active and Passive Smart Structures and Integrated Systems XIII*, Vol. 10967, International Society for Optics and Photonics; 2019. p. 1096715.
- [36] Sun H, Zuo L, Wang X, Peng J, Wang W. Exact h2 optimal solutions to inerter-based isolation systems for building structures. *Struct Control Health Monit* 2019;26(6):e2357.
- [37] Zhao Z, Chen Q, Zhang R, Pan C, Jiang Y. Energy dissipation mechanism of inerter systems. *Int J Mech Sci* 2020;184:105845.
- [38] Moghimi G, Makris N. Seismic response of yielding structures equipped with inerters. *Soil Dyn Earthq Eng* 2020;106474.
- [39] Li L, Liang Q. Effect of inerter for seismic mitigation comparing with base isolation. *Struct Control Health Monit* 2019;26(10):e2409.
- [40] Jiang Y, Zhao Z, Zhang R, De Domenico D, Pan C. Optimal design based on analytical solution for storage tank with inerter isolation system. *Soil Dyn Earthq Eng* 2020;129:105924.
- [41] Zhao Z, Zhang R, Wierschem NE, Jiang Y, Pan C. Displacement mitigation-oriented design and mechanism for inerter-based isolation system. *J Vib Control* 2020;1077546320951662.
- [42] De Domenico D, Ricciardi G, Zhang R. Optimal design and seismic performance of tuned fluid inerter applied to structures with friction pendulum isolators. *Soil Dyn Earthq Eng* 2020;132:106099.
- [43] Zhao Z, Zhang R, Jiang Y, Pan C. Seismic response mitigation of structures with a friction pendulum inerter system. *Eng Struct* 2019;193:110–20.
- [44] Zhao Z, Chen Q, Zhang R, Pan C, Jiang Y. Optimal design of an inerter isolation system considering the soil condition. *Eng Struct* 2019;196:109324.
- [45] Zhang R, Zhao Z, Pan C. Influence of mechanical layout of inerter systems on seismic mitigation of storage tanks. *Soil Dyn Earthq Eng* 2018;114:639–49.
- [46] Zhang R, Zhao Z, Dai K. Seismic response mitigation of a wind turbine tower using a tuned parallel inerter mass system. *Eng Struct* 2019;180:29–39.
- [47] Taflanidis AA, Giaralis A, Patsialis D. Multi-objective optimal design of inerter-based vibration absorbers for earthquake protection of multi-storey building structures. *J Franklin Inst* 2019;356(14):7754–84.
- [48] Čakmak D, Tomićević Z, Wolf H, Božić Z, Semenski D, Trapić I. Vibration fatigue study of the helical spring in the base-excited inerter-based isolation system. *Eng Failure Anal* 2019;103:44–56.
- [49] Chen MZ, Hu Y. Analysis for inerter-based vibration system. In *Inerter and Its Application in Vibration Control Systems*, Springer; 2019. pp. 19–39.
- [50] Yilmaz C, Hulbert GM, Kikuchi N. Phononic band gaps induced by inertial amplification in periodic media. *Phys Rev B* 2007;76(5):054309.
- [51] Taniker S, Yilmaz C. Design, analysis and experimental investigation of three-dimensional structures with inertial amplification induced vibration stop bands. *Int J Solids Struct* 2015;72:88–97.
- [52] Yilmaz C, Hulbert G. Theory of phononic gaps induced by inertial amplification in finite structures. *Phys Lett A* 2010;374(34):3576–84.
- [53] Taniker S, Yilmaz C. Phononic gaps induced by inertial amplification in bcc and fcc lattices. *Phys Lett A* 2013;377(31–33):1930–6.
- [54] Yuksel O, Yilmaz C. Shape optimization of phononic band gap structures incorporating inertial amplification mechanisms. *J Sound Vib* 2015;355:232–45.
- [55] Taniker S, Yilmaz C. Generating ultra wide vibration stop bands by a novel inertial amplification mechanism topology with flexure hinges. *Int J Solids Struct* 2017;106:129–38.
- [56] Yuksel O, Yilmaz C. Realization of an ultrawide stop band in a 2-d elastic metamaterial with topologically optimized inertial amplification mechanisms. *Int J Solids Struct* 2020;203:138–50.
- [57] Barys M, Zalewski R. Analysis of inertial amplification mechanism with smart spring-damper for attenuation of beam vibrations. In *MATEC Web of Conferences*, vol. 157, EDP Sciences; 2018. p. 03002.
- [58] Yilmaz C, Hulbert GM. Dynamics of locally amplified and inertially amplified lattice materials. *Dynamics of Lattice Materials*; Phani, AS, Hussein, MI, Eds; 2017. 233.
- [59] Mi Y, Yu X. Sound transmission of acoustic metamaterial beams with periodic inertial amplification mechanisms. *J Sound Vib* 2021;499:116009.
- [60] Zhou J, Dou L, Wang K, Xu D, Ouyang H. A nonlinear resonator with inertial amplification for very low-frequency flexural wave attenuations in beams. *Nonlinear Dyn* 2019;96(1):647–65.
- [61] Barys M, Jensen JS, Frandsen NM. Efficient attenuation of beam vibrations by inertial amplification. *Eur J Mech-A/Solids* 2018;71:245–57.
- [62] Muhammad S, Wang S, Li F, Zhang C. Bandgap enhancement of periodic nonuniform metamaterial beams with inertial amplification mechanisms. *J Vib Control* 2020;1077546319895630.
- [63] Sun F, Dai X, Liu Y, Xiao L. Seismic mitigation performance of periodic foundations with inertial amplification mechanism considering superstructure-foundation interaction. *Smart Mater Struct* 2021;30(2):025018.
- [64] Frandsen NM, Bilal OR, Jensen JS, Hussein MI. Inertial amplification of continuous structures: Large band gaps from small masses. *J Appl Phys* 2016;119(12):124902.
- [65] Cheng Z, Palermo A, Shi Z, Marzani A. Enhanced tuned mass damper using an inertial amplification mechanism. *J Sound Vib* 2020;115267.
- [66] Hou M, Wu JH, Cao S, Guan D, Zhu Y. Extremely low frequency band gaps of beam-like inertial amplification metamaterials. *Modern Phys Lett B* 2017;31(27):1750251.
- [67] Yilmaz G, Hulbert, Kikuchi N. Phononic band gaps induced by inertial amplification in periodic media. *Phys Rev B* 2007;76:054309.
- [68] Miniaci M, Mazzotti M, Amendola A, Fraternali F. Inducing dispersion curves with negative group velocity in inertially amplified phononic crystals through the application of an external state of prestress. In: *XI International Conference on Structural Dynamic EURO-DYN 2020*; 2020. p. 612–20.
- [69] Roberts JB, Spanos PD. Random vibration and statistical linearization. *Courier Corporation* 2003.
- [70] Adhikari S, Pascual B. The ‘damping effect’ in the dynamic response of stochastic oscillators. *Probabilistic Eng Mech* 2016;44(4):2–17.
- [71] Jacquelin E, Brizard D, Adhikari S, Friswel MI. Time-domain response of damped stochastic multiple-degree-of-freedom systems. *ASCE J Eng Mech* 2020;146(1):06019005:1–7.
- [72] Banerjee A, Chanda A, Das R. Seismic analysis of a curved bridge considering deck-abutment pounding interaction: an analytical investigation on the post-impact response. *Earthq Eng Struct Dyn* 2017;46(2):267–90.
- [73] Kras A, Gardonio P. Active vibration control unit with a flywheel inertial actuator. *J Sound Vib* 2020;464:114987.