



Fuzzy uncertainty propagation in composites using Gram–Schmidt polynomial chaos expansion



S. Dey*, T. Mukhopadhyay, H. Haddad Khodaparast, S. Adhikari

College of Engineering, Swansea University, United Kingdom

ARTICLE INFO

Article history:

Received 5 December 2014

Revised 11 November 2015

Accepted 24 November 2015

Available online 2 December 2015

Keywords:

Uncertainty

Fuzzy

Composite

Gram–Schmidt polynomial chaos

Fuzzy natural frequency

Fuzzy mode shapes

ABSTRACT

The propagation of uncertainty in composite structures possesses significant computational challenges. Moreover, probabilistic descriptions of uncertain model parameters are not always available due to lack of data. This paper investigates on the uncertainty propagation in dynamic characteristics (such as natural frequencies, frequency response function and mode shapes) of laminated composite plates by using fuzzy approach. In the proposed methodology, non-intrusive Gram–Schmidt polynomial chaos expansion (GPCE) method is adopted in uncertainty propagation of structural uncertainty to dynamic analysis of composite structures, when the parameter uncertainties represented by fuzzy membership functions. A domain in the space of input data at zero-level of membership functions is mapped to a zone of output data with the parameters determined by D-optimal design. The obtained meta-model (GPCE) can also be used for higher α -levels of fuzzy membership function. The most significant input parameters such as ply orientation angle, elastic modulus, mass density and shear modulus are identified and then fuzzified. The proposed fuzzy approach is applied to the problem of fuzzy modal analysis for frequency response function of a simplified composite cantilever plates. The fuzzy mode shapes are also depicted for a typical laminate configuration. Fuzzy analysis of the first three natural frequencies is presented to illustrate the results and its performance. The proposed approach is found more efficient compared to the conventional global optimization approach in terms of computational time and cost.

© 2015 Elsevier Inc. All rights reserved.

1. Introduction

Composite materials have gained immense popularity in application of aerospace, marine, automobile and construction industries due to its weight sensitivity and cost-effectiveness. Such structures are prone to considerable uncertainty in their fiber and material parameters. During production of composite materials, it is always subjected to large variability due to unavoidable manufacturing imperfection, operational factors, lack of experience and precise test data. Therefore, it is important to investigate the structural behavior of composites due to the variability of parameters in each constituent laminate level. This information predicts the correlation between the dynamic characteristics, input-output variables and structural health. Typical uncertainties incurred are intra-laminate voids, incomplete curing of resin, excess resin between plies, excess matrix voids, porosity, variations in ply thickness and fiber parameters. In practice, an additional factor of safety is assumed by designers due to difficulty in quantifying those uncertainties. This existing practice of designer results in either an ultraconservative or an unsafe design.

* Corresponding author. Tel.: +44 7465056227, +91 7086880231.

E-mail address: infosudip@gmail.com, S.Dey@swansea.ac.uk (S. Dey).

Uncertainty can be modeled either by probabilistic or non-probabilistic approach. Due to availability of limited sample experimental or testing data (crisp inputs), it will be more realistic to follow non-probabilistic approach rather than probabilistic approach. In recent years, significant advances have been made in representing uncertainty in composite material properties by probabilistic models. However, there has been little attention in the use of non-probabilistic models such as fuzzy. In most recent studies, the probability density function is used to portray the map of volatility in output characteristics while many procedures such as Monte Carlo simulation and probabilistic finite element method [1], random field [2] models, random matrix [3], and generalized polynomial chaos with Karhunen–Loève expansion [4] are employed. The propagation of structural uncertainty in laminated composite structures is carried out by probabilistic approach [5,6]. Following random variable based probabilistic approach stochastic analysis for free vibration responses of composite plates and shells are reported recently including the effects of uncertainties associated with twist angle, rotation and environmental factors such as temperature [7–9]. However, these methods usually need large volumes of data, which are expensive and computational costs are high. An alternative approach, assuming that large quantities of test data are not available, would be to use non-probabilistic methods such as interval and fuzzy. Fuzzy finite element analysis [10–11] aims to combine the power of finite element method and uncertainty modelling capability of fuzzy variables. One way to view a fuzzy input-output variable is the universality of an interval variable. It should be noted that the intervals do not represent the values of the variable, but the knowledge about the range of possible values that a variable can take. For an uncertain variable represented by interval, the values of the parameters can be observed within the two bounds (lower and upper). A membership function is introduced in fuzzy approach [12]. In real-life problems, original Monte Carlo simulation is expensive due to high computational time. Therefore, the aim of the majority of current research is to reduce the computational cost. Under the possibilistic interpretation of fuzzy sets [13] and uncertainty environment [14], fuzzy variables would become a generalized interval variables. Consequently techniques employed in interval analysis such as classical interval arithmetic [15], affine analysis [16] or vertex theorems [17] can be used. The Neumann expansion [18], the transformation method [19], and response surface based methods [20] are proposed for fuzzy analysis. In this context, recently fuzzy analysis is employed to deal with uncertainties in engineering problems using only available data [21]. Earlier fuzzy approach has been applied to safety analysis [22], random system properties [23] and optimal design [24]. In contrast, PCE approach [25] for material uncertainty effect on vibration control of smart composite plate and High Dimensional Model Representation (HDMR) approach are proposed [26] for the propagation of fuzzy uncertain variables through a complex finite element model. The fracture and fatigue damage response of composite materials is studied by using fuzzy [27] while the robust stabilization design of nonlinear stochastic partial differential systems by Fuzzy approach [28] and a fuzzy-probabilistic approach introduced for strain-hardening cement-based composites [29]. Of late, the modeling uncertainty for risk assessment is studied by an integrated approach with fuzzy set theory and Monte Carlo simulation [30]. The fuzzy logic based approach to FRP retrofit of columns [31] and grey-fuzzy algorithm [32] on composites are studied while experimental study with fuzzy logic modeling [33] is also investigated. The coupling of fuzzy concepts [34,35] and the modeling of arbitrary uncertainties using Gram–Schmidt polynomial chaos [36] can open a novel idea of research.

In general, Monte Carlo simulation technique is popularly utilized to generate the uncertain random output frequency dealing with large sample size. Although the uncertainty in material and geometric properties can be computed by direct Monte Carlo Simulation, it is inefficient and incurs high computational cost. Recently, the authors developed a fuzzy uncertainty propagation method [37] based on Legendre orthogonal polynomial chaos which was intrusively applied to static analysis of a rod with uncertain stiffness parameters. The present study employs the use of Gram–Schmidt algorithm based polynomial chaos expansion in propagation of structural uncertainties of composite structures, when parameter uncertainties are represented by fuzzy membership functions. In practice, the fuzzy models can be used when there is lack of data to estimate an accurate PDF of the uncertain parameters. This paper considers the application of the fuzzy propagation method to dynamic analysis of laminated composite plates with realistic uncertain parameters such as ply orientation. The polynomial chaos terms are determined by the method explained in Section 2. The obtained polynomial chaos expansion acts as a surrogate model (meta-model) for the full finite element model of composite structure. The regression coefficients of the PCE are then determined by first sampling in the space of input parameters (D-optimal design [38,39] in this paper) and then a least square technique. Since the widest range of input parameters are considered to be at zero membership function, the regression coefficients can be obtained once at this level and used for all highest α -cuts. The application of fuzzy PCE approach for uncertainty quantification in the field of composite structures is the first attempt of its kind to the best of authors' knowledge. The code which was developed by the authors in an earlier literature [40] is combined non-intrusively with the proposed method in this present study to treat uncertainty associated with complex systems like laminated composite structures. In the present study, four layered graphite–epoxy composite laminated cantilever plate is considered as furnished in Fig. 1.

2. Theoretical formulation

In the fuzzy concept [36], a set of transitional states between the members and non-members are defined via a membership function $[\mu_{p_i}]$ that indicates the degree to which each element in the domain belongs to the fuzzy set. The fuzzy number $[\tilde{p}_i(\tilde{\omega}_\alpha)]$ considering triangular membership function can be expressed as,

$$\tilde{p}_i(\tilde{\omega}_\alpha) = [p_i^U, p_i^M, p_i^L], \quad (1)$$

where p_i^M , p_i^U and p_i^L denote the mean value, the upper bound and lower bounds, respectively. $\tilde{\omega}_\alpha$ indicates the fuzziness corresponding to α -cut where α is known as membership grade or degree of fuzziness ranging from 0 to 1.

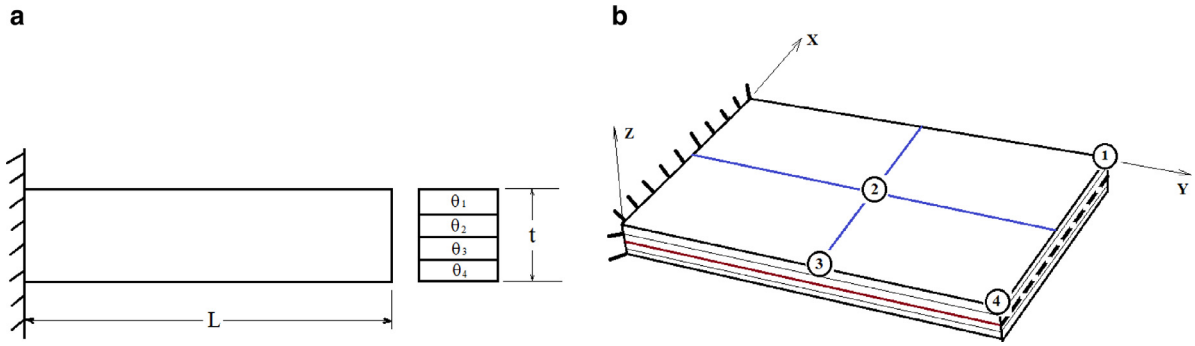

Fig. 1. (a,b) Laminated composite cantilever plate.

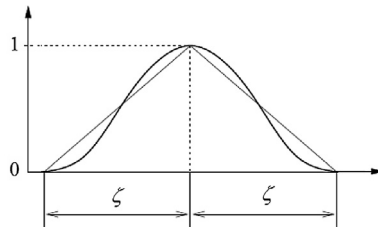

Fig. 2. Linear approximation of a Gaussian distribution by triangular fuzzy.

The Gaussian probability function may be approximated by a triangle by equating the area under the normalized Gaussian distribution function [35] with the area under triangular membership function as shown in Fig. 2. This is just an example to show how a fuzzy membership function can be constructed from a given PDF. In practice, when there is limited measured data, the fuzzy membership function of uncertain data can be constructed using histogram (such as in [41]). As a result of this approximation the triangular fuzzy membership function can be defined as

$$\mu_{p(i)} = \max \left[0, 1 - \frac{|X_i^{(j)} - \hat{X}_i|}{\zeta} \right], \tag{2}$$

where $\zeta = \sqrt{2\pi}\sigma_X$, \hat{X}_i and σ_X are the mean and standard deviation of the equivalent Gaussian distribution. In this paper, the triangular shaped membership function is employed. Now the membership function $[\mu_{p(i)}]$ can be expressed as

$$\begin{aligned} \mu_{p(i)} &= 1 - (p_i^M - p_i)/(p_i^M - p_i^L), & \text{for } p_i^L \leq p_i \leq p_i^M \\ \mu_{p(i)} &= 1 - (p_i - p_i^M)/(p_i^U - p_i^M), & \text{for } p_i^M \leq p_i \leq p_i^U \\ \mu_{p(i)} &= 0 & \text{Otherwise.} \end{aligned} \tag{3}$$

The fuzzy input number p_i can be expressed into the set P_i of $(m+1)$ intervals $p_i^{(j)}$ using the α -cut method

$$P_i(\tilde{\omega}_\alpha) = [p_i^{(0)}, p_i^{(1)}, p_i^{(2)} \dots p_i^{(j)} \dots p_i^{(m)}], \tag{4}$$

where m denotes the number of α -cut levels. The interval of the j th level of the i th fuzzy number is given by

$$p_i^{(j)} = [p_i^{(j,L)}, p_i^{(j,U)}], \tag{5}$$

where $p_i^{(j,L)}$ and $p_i^{(j,U)}$ denote the lower and upper bounds of the interval at the j th level, respectively. At $j = m$, $p_i^{(m,L)} = p_i^{(m,U)} = p_i^M$. The superscripts L and U denote the lower and upper bounds, respectively.

In order to propagate uncertainty in a system where uncertain model parameters are represented by fuzzy input numbers, one may apply a numerical procedure of interval analysis at a number of α -levels [11]. In this case, the range of the response components on a specific level of membership function is searched within the same α -level on the input domain, which means that the analysis at each α -cut corresponds to an interval analysis for the system. In the present analysis, the orthogonal polynomial chaos basis functions, derived from Gram–Schmidt algorithm [36] is employed for uncertainty propagation, as depicted in Fig. 3. Fig. 3 shows the scheme for particular case of two input parameters and one output but the idea can be readily generalized for the case of multi-inputs multi-outputs. The solution to fuzzy generalized equation at each α -level may be expanded into a polynomial chaos expansion as follows:

$$\mathbf{y}^{(\alpha)} = \mathbf{B}^{(\alpha)} \psi(\mathbf{p}^{(\alpha)}) \quad \text{for } \alpha = \alpha_k, k = 1, 2, \dots, r, \tag{6}$$

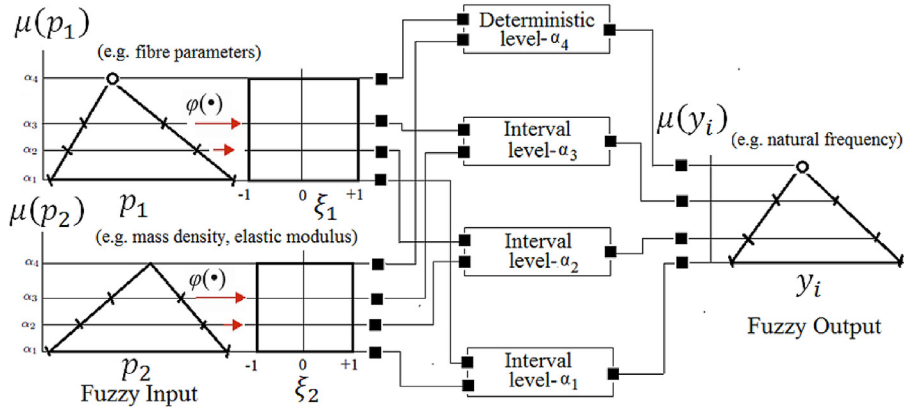

Fig. 3. Scheme for fuzzy analysis including transformation $\phi(\cdot)$ of a fuzzy variable p_i to $\xi \in [-1,1]$ for different α -cuts.

where $\mathbf{y}^{(\alpha)} = [y_1^{(\alpha)} y_2^{(\alpha)} \dots y_n^{(\alpha)}]^T \in \mathbb{R}^{n \times 1}$ denotes the assembled vector of output data at $\alpha = \alpha_k$ (the subscript k is removed from α_k for reason of simplicity), $\psi(\mathbf{p}^{(\alpha)}) = \text{vec}(\Psi(\mathbf{p}^{(\alpha)})) \in \mathbb{R}^{p \times 1}$ denotes the assembled vector of Gram–Schmidt polynomial chaos basis functions, to be explained in the sequel and \mathbf{B} is expressed as

$$\mathbf{B} = \begin{bmatrix} \beta_0^{(1)} & \beta_1^{(1)} & \beta_2^{(1)} & \dots & \beta_p^{(1)} \\ \beta_0^{(2)} & \beta_1^{(2)} & \beta_2^{(2)} & \dots & \beta_p^{(2)} \\ \beta_0^{(3)} & \beta_1^{(3)} & \beta_2^{(3)} & \dots & \beta_p^{(3)} \\ \vdots & \vdots & \vdots & \ddots & \vdots \\ \beta_0^{(n)} & \beta_1^{(n)} & \beta_2^{(n)} & \dots & \beta_p^{(n)} \end{bmatrix}, \tag{7}$$

where $\beta_k^{(i)}$ are the coefficients of polynomial expansion with $k = 1, 2, 3, \dots, p$ (p is the number of terms retained in the expansion), n is the number of output parameters, $\mathbf{p}^{(\alpha)} = [p_1^{(\alpha)} p_2^{(\alpha)} \dots p_m^{(\alpha)}]^T \in \mathbb{R}^{m \times 1}$ is an m -dimensional vector of interval variables at $\alpha = \alpha_k$. As it is already mentioned in the paper, we represent a fuzzy variable with a set of interval variables via the membership function. The lower and upper bounds of interval variables at different α -levels (i.e., $p_i^{(\alpha,L)}$, $p_i^{(\alpha,U)}$) can be transformed into the normalized values of -1 and 1 , respectively. As explained in [37], this is because the solution to Legendre’s differential equation is convergent when the random variables are between -1 and 1 . This mapping can be done for any other type of probability distribution function, e.g. Hermite polynomials. The mapping process is shown in Fig. 3. The transformation function $\phi(\cdot)$ and its inverse function can be obtained as

$$\xi_i = \phi(p_i) = 2 \left(\frac{p_i^\alpha - p_i^{(\alpha,L)}}{p_i^{(\alpha,U)} - p_i^{(\alpha,L)}} - \frac{1}{2} \right), \tag{8}$$

$$p_i^\alpha = \phi^{-1}(\xi_i) = \frac{(p_i^{(\alpha,U)} - p_i^{(\alpha,L)})}{2} \xi_i + \frac{(p_i^{(\alpha,U)} + p_i^{(\alpha,L)})}{2}. \tag{9}$$

The fuzzy propagation starts with a deterministic solution at $\alpha = 1$ and will continue by interval analysis at lower α -level cuts by substituting p_i^α in Eq. (6) for all $i = 1, 2, \dots, m$ and all alpha-cuts ($\alpha = \alpha_k, k = 1, 2, \dots, r$). Consequently the fuzzy propagation can be expressed in terms of the vector valued variable ($\xi = [\xi_1, \xi_2, \dots, \xi_m]^T \in \mathbb{R}^{m \times 1}$) as indicated in Eq. (10).

The Gram–Schmidt algorithm used in this analysis to derive polynomial expressions $\Psi(\xi)$ that map a domain in the space of input data ‘ ξ ’ to a zone of output data. In this case, Eq. (6) can be written as

$$\mathbf{y}^{(\alpha)} = \mathbf{B}\psi(\xi), \tag{10}$$

where $\psi(\xi) = \text{vec}(\Psi(\xi)) \in \mathbb{R}^{p \times 1}$ and $\Psi(\xi)$ is a matrix that can be obtained by tensor product of the ‘ m ’ one dimensional orthogonal polynomials $\{\psi_0(\xi_i), \psi_1(\xi_i), \dots, \psi_h(\xi_i)\}$. The one dimensional polynomials are computed from classical Gram–Schmidt algorithm [36]. In this method, the polynomial terms are represented as $\psi_j(\xi_i) = \xi_i^j + O(\xi_i^{j-1})$ where $j = 0, 1, \dots, h$. This results in $\psi_0(\xi_i) = 1$ and the remaining terms are computed using the following recursive equations:

$$\psi_j(\xi_i) = e_j(\xi_i) - \sum_{k=0}^{j-1} c_{jk} \psi_k(\xi_i), \tag{11}$$

where

$$c_{jk} = \frac{\int_{-1}^1 e_j(\xi_i) \psi_k(\xi_i) d\xi_i}{\int_{-1}^1 \psi_k^2(\xi_i) d\xi_i}.$$

The D-optimal design approach [38,39] is employed to evaluate the input design points for the respective samples at each α -cut and subsequently those values are called for finite element iteration. The goodness of the present model obtained by least squares regression analysis is the minimum generalized variance of the estimates of the model coefficients. D-optimality is achieved if the determinant of $(Z^T Z)^{-1}$ is minimal where Z denotes the design matrix as a set of value combinations of coded parameters and Z^T is the transpose of Z .

In this paper, the application of the above proposed method is demonstrated in laminated composite cantilever plate considering uncertain input parameters as ply orientation angle, elastic modulus, mass density and shear modulus while output parameters are considered as natural frequency, modal frequency response function and mode shapes [$\mathbf{y}^{(\alpha)}$ in Eq. (10)]. The dynamic equation of motion of the system shown in Fig. 1 can be expressed as:

$$\mathbf{M}(\tilde{\omega}_\alpha) \ddot{\boldsymbol{\delta}} + \mathbf{C}(\tilde{\omega}_\alpha) \dot{\boldsymbol{\delta}} + \mathbf{K}(\tilde{\omega}_\alpha) \boldsymbol{\delta} = \mathbf{0}, \tag{12}$$

where $\mathbf{M}(\tilde{\omega}_\alpha)$ is the mass matrix, $\mathbf{C}(\tilde{\omega}_\alpha)$ is damping matrix, $\mathbf{K}(\tilde{\omega}_\alpha)$ is the stiffness matrix and $\boldsymbol{\delta}$, $\dot{\boldsymbol{\delta}}$ and $\ddot{\boldsymbol{\delta}}$ are displacement, velocity and acceleration vectors. The governing equations are derived based on Mindlin's theory incorporating rotary inertia, transverse shear deformation [40] using an eight noded isoparametric plate bending element [42]. More details of derivation of the equation of motion are given in [6]. The composite plate is assumed to be lightly damped and the natural frequencies of the system are obtained as:

$$\omega_j^2(\tilde{\omega}_\alpha) = \frac{1}{\lambda_j(\tilde{\omega}_\alpha)} \quad j = 1, \dots, n_r, \tag{13}$$

where $\lambda_j(\tilde{\omega}_\alpha)$ is the j th eigenvalue of matrix $\mathbf{A} = \mathbf{K}^{-1}(\tilde{\omega}_\alpha) \mathbf{M}(\tilde{\omega}_\alpha)$ and n_r indicates the number of modes retained in this analysis. Using the transformation $\boldsymbol{\delta}(t) = [\Phi] \mathbf{q}(t)$, Eq. (12) can be decoupled in the modal coordinates as:

$$\ddot{q}_j(t) + 2\zeta_j \omega_j \dot{q}_j(t) + \omega_j^2 q_j(t) = 0 \quad j = 1, \dots, n_r, \tag{14}$$

where ζ_j is the damping factor, $[\Phi] \in \mathbb{R}^{n \times n_r}$ is a matrix whose columns are the eigenvectors of the system and $q_j(t)$ is the j th component of vector $\mathbf{q}(t)$. The generalized proportional damping model expresses the damping matrix as a linear combination of the mass and stiffness matrices, that is

$$\mathbf{C}(\tilde{\omega}_\alpha) = \alpha_1 \mathbf{M}(\tilde{\omega}_\alpha), \tag{15}$$

where $\alpha_1 = 0.005$ is constant damping factor. In this case, the damping is said to be proportional damping. The components of transfer function matrix of the system with proportional damping can be obtained as

$$H_{ik}(j\omega)(\tilde{\omega}_\alpha) = \sum_{l=1}^n \frac{\Phi_{l_i}(\tilde{\omega}_\alpha) \Phi_{l_k}(\tilde{\omega}_\alpha)}{-\omega^2 + 2i\omega\zeta_l\omega_l + \omega_l^2}, \tag{16}$$

where $\Phi_{l_i}(\tilde{\omega}_\alpha)$ and $\Phi_{l_k}(\tilde{\omega}_\alpha)$ are the i th and the k th components of the l th fuzzy mode shape $\Phi_l(\tilde{\omega}_\alpha)$. Therefore, the dynamic response of proportionally damped system can be expressed as a linear combination of the undamped mode shapes. As mentioned earlier, the Fuzzy outputs in Eq. (10) are the natural frequencies in Eq. (13), the component of mode shapes e.g. $\Phi_{l_i}(\tilde{\omega}_\alpha)$ and the components of frequency response function given by Eq. (16).

3. Fuzzy input representation

The fuzziness of input parameters such as ply-orientation angle, elastic modulus, mass density and shear modulus at each layer of laminate are considered for composite cantilever plates. It is assumed that the distribution of fuzzy input parameters exists within a certain tolerance zone with their crisp values. The cases wherein the fuzzy input variables considered in each layer of laminate are as follows:

- (a) Variation of ply-orientation angle only: $\theta(\tilde{\omega}_\alpha) = \{\theta_1 \theta_2 \theta_3 \dots \theta_l \dots \theta_l\}$
- (b) Variation of longitudinal elastic modulus only: $E_1(\tilde{\omega}_\alpha) = \{E_{1(1)} E_{1(2)} E_{1(3)} \dots E_{1(i)} \dots E_{1(l)}\}$
- (c) Variation of mass density only: $\rho(\tilde{\omega}_\alpha) = \{\rho_1 \rho_2 \rho_3 \dots \rho_i \dots \rho_l\}$
- (d) Variation of longitudinal shear modulus only: $G_{12}(\tilde{\omega}_\alpha) = \{G_{12(1)} G_{12(2)} G_{12(3)} \dots G_{12(i)} \dots G_{12(l)}\}$
- (e) Combined variation of ply orientation angle, longitudinal elastic modulus, mass density and shear modulus (longitudinal): $g[\theta, E_1, \rho, G_{12}(\tilde{\omega}_\alpha)] = [\Phi_1(\theta_1 \dots \theta_l), \Phi_2(E_{1(1)} \dots E_{1(l)}), \Phi_3(\rho_1 \dots \rho_l), \Phi_4(G_{12(1)} \dots G_{12(l)})]$.

where $\theta_{(i)}$, $E_{1(i)}$, $\rho_{(i)}$ and $G_{12(i)}$ are the ply orientation angle, elastic modulus (longitudinal), mass density and shear modulus (longitudinal), respectively and ' l ' denotes the number of layer in the laminate. For individual and combined cases, the number of variables (n_v) are considered as 4 and 16, respectively. In present study, $\pm 5^\circ$ for ply orientation angle and $\pm 10\%$ tolerance for material properties respectively from fuzzy crisp values are considered. The membership grades are considered as 0–1 in step of 0.1. Fig. 4 presents the flowchart of present fuzzy approach.

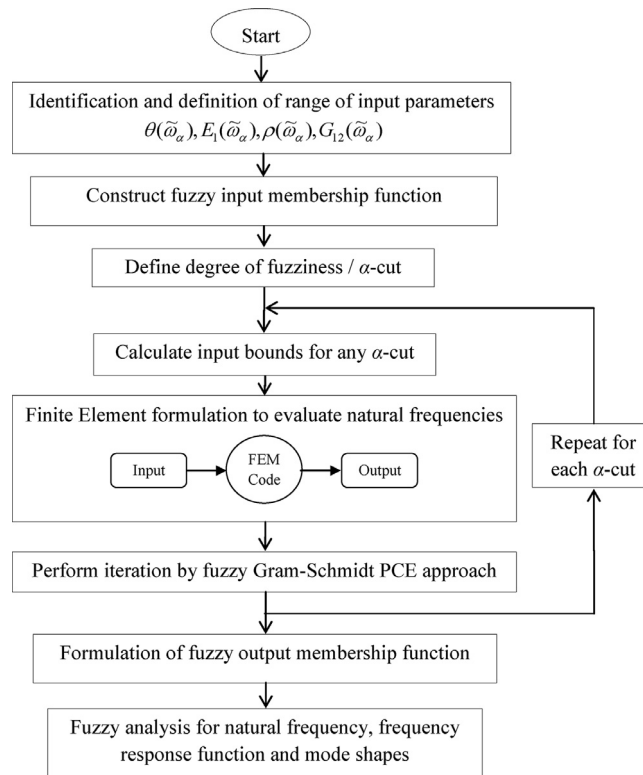

Fig. 4. Flowchart of frequency responses using fuzzy.

Table 1

Convergence study for non-dimensional fundamental natural frequencies [$\omega = \omega_n L^2 \sqrt{(\rho/E_1 t^2)}$] of three layered ($\theta^\circ/-\theta^\circ/\theta^\circ$) graphite–epoxy twisted composite plates, $a/b = 1$, $b/t = 100$, considering $E_1 = 138$ GPa, $E_2 = 8.96$ GPa, $G_{12} = 7.1$ GPa, $\nu_{12} = 0.3$.

Ply orientation angle, θ	Present FEM (4×4)	Present FEM (6×6)	Present FEM (8×8)	Present FEM (10×10)	Qatu and Leissa [45]
0°	1.0112	1.0133	1.0107	1.004	1.0175
45°	0.4556	0.4577	0.4553	0.4549	0.4613
90°	0.2553	0.2567	0.2547	0.2542	0.2590

4. Results and discussion

The present study considers four layered graphite–epoxy angle-ply [$(\theta^\circ/-\theta^\circ/\theta^\circ/-\theta^\circ)$] and cross-ply ($0^\circ/90^\circ/0^\circ/90^\circ$) composite cantilever plates. Material properties of graphite–epoxy composite [43] considered with deterministic value as $E_1 = 138$ GPa, $E_2 = 8.96$ GPa, $\nu = 0.3$, $G_{12} = G_{13} = 7.1$ GPa, $G_{23} = 2.84$ GPa, $\rho = 1600$ kg/m³. In general, the performance function is not available as an explicit function of the random design variables for complex composite structures. The fuzzy response in terms of natural frequencies of the composite structure can only be evaluated numerically at the end of a structural analysis procedure such as the finite element method which is often time-consuming. The present fuzzy model is employed to find non-probabilistic responses by predefined range of variations in input parameters. The fuzzy membership functions are used to determine the first three natural frequencies corresponding to given values of input variables with different degree of fuzziness. The uncertainty propagation of fuzzy variables can be carried out by interval approach and global optimization approach. In the first approach, a fuzzy variable is considered as an interval variable for each α -cut by employing classical interval arithmetic [44]. Moreover, for multiple occurrence of interval valued variables, the fuzzy expression maximizes the deviation of results from true values and thus makes the overestimation effect. Such overestimation will not be applicable to design decisions. In contrast, for the global optimization based approach, two optimization problems are solved to find fuzzy output quantities for each α -cut. If there are multiple local optima for the objective function in the optimization problem, the global optimization is used to find the globally best solution. In the present study, the fuzzy polynomial chaos expansion (PCE) approach is adopted for uncertainty propagation in composite structures wherein the large number of fuzzy input variables are considered to optimize the upper and lower bound for output quantity of interest (natural frequency). The first three fuzzy natural frequencies are approximated by using the proposed fuzzy PCE method described in Section 2. The present computer code for fuzzy model is validated with the results available in the open literature. Table 1 presents the convergence study of non-dimensional fundamental natural frequencies of

Table 2

Convergence study for order of polynomial in PCE model for maximum and minimum values of first three natural frequencies considering combined variation of ply-orientation angle, elastic modulus, shear modulus and mass density for four layered graphite–epoxy angle-ply ($45^\circ/-45^\circ/45^\circ/-45^\circ$) composite cantilever plate (FNF – Fundamental natural frequency, SNF – Second natural frequency, TNF – Third natural frequency).

Mode	Value	Order of polynomial				
		1	2	3	4	5
FNF	Max	6.3868	6.1996	6.1969	6.1719	6.1706
	Min	5.5876	5.3000	5.3231	5.2881	5.2891
	Max	17.5101	17.9752	17.8513	17.8873	17.9041
SNF	Min	16.9653	16.1847	16.4643	16.4278	16.4072
	Max	38.9485	38.0000	38.3018	38.2333	38.2382
TNF	Min	33.9329	33.0011	33.1779	33.0291	33.0316

three layered ($\theta^\circ/-\theta^\circ/\theta^\circ$) graphite–epoxy untwisted composite plates [45]. Based on convergence study, a typical discretization of (6×6) mesh on plan area with 36 elements 133 nodes with natural coordinates of an isoparametric quadratic plate bending element are considered for the present finite element method. The present study investigates on a reliable representation for uncertainty quantification of frequency responses of laminated composite plates using fuzzy membership function approach. The propagation of uncertainties is also demonstrated in the estimation of structural responses of composite cantilever plates. The variations of fuzzy input variables of composite plate namely, ply-orientation angle, elastic modulus, mass density and shear modulus are considered as furnished in Fig. 5. Another convergence study is carried out in conjunction to order of PCE model, as depicted in Table 2. There is a trade off between accuracy and computational cost found with the increase of order of polynomial i.e., a higher order polynomial yields a slightly higher level of accuracy but it costs comparatively much higher computational time and vice-versa. Hence, to balance between accuracy and computational cost, percentages of errors in results (i.e., maximum and minimum stochastic first three natural frequencies) are kept well below 1%. In order to maintain adequate level of accuracy and to optimize the computational time, the second order of polynomial is selected in the present study. Due to paucity of space, only a few important representative results are furnished.

The variation of elastic modulus, mass density and shear modulus are scaled in the range with the lower and the upper limit (tolerance limit) as $\pm 10\%$ variability (as per standard of composite manufacturing industry) with respective mean values while for ply orientation angle [$\theta(\tilde{\omega}_\alpha)$] ranging from 0° to 90° in step of 15° in each layer of the composite laminate at the lower bound is considered as within $\pm 5^\circ$ fluctuation (as per standard of composite manufacturing industry) with respective mean deterministic values. The fuzzy models are formed to generate the maximum and minimum bounds for each α -cut of the first three natural frequencies for graphite–epoxy composite cantilever plates. Both angle-ply and cross-ply laminated composite cantilever plates are considered for the present analysis. For variation in only ply orientation angle, it is found that the fundamental natural frequency decreases as the ply orientation angle increases from 0° to 90° in the step of 15° irrespective of α -cut as furnished in Fig. 6. This is expected as the fundamental mode is bending and the bending stiffness of the composite plate falls when ply orientation angle increases. In contrast, for variation in only ply orientation angle, the second and third natural frequencies increases as the ply orientation angle increases from 0° to 30° in the step of 15° and subsequently decreases as the ply orientation angle increases from 45° to 90° in the step of 15° irrespective of α -cut. This is owing to the fact that the second and third modes are torsion and the maximum torsion stiffness is expected to be at about 45° while the minimum values are around 0° and 90° . It is also observed that the least variation in natural frequency at $\alpha = 0$ is identified for $\theta(\tilde{\omega}_\alpha) = 90^\circ$ for the first three natural frequencies. This can be attributed to the fact that the sensitivity of elastic stiffness is minimum for the fuzziness of ply orientation angle at $\theta(\tilde{\omega}_\alpha) = 90^\circ$. For only variation in ply orientation angle, the maximum bound width (difference between maximum and minimum natural frequencies) is observed at $\alpha = 0$ and the minimum bound width is identified at $\alpha = 1$ for the first three natural frequencies as furnished in Fig. 7. The maximum bound width for fundamental natural frequency is found for $\theta(\tilde{\omega}_\alpha) = 15^\circ$ while the minimum bound width is identified for $\theta(\tilde{\omega}_\alpha) = 90^\circ$ irrespective of α -cut. In contrast, the maximum bound width for second and third natural frequencies are observed at $\theta(\tilde{\omega}_\alpha) = 60^\circ$ and $\theta(\tilde{\omega}_\alpha) = 45^\circ$, respectively while the minimum bound width is consistently identified for $\theta(\tilde{\omega}_\alpha) = 90^\circ$ irrespective of α -cut. This could be attributed to the fact that the elastic stiffness for each α -cut of the fuzzy variation leads to such variation in natural frequencies and consequently the range of frequency response corresponding to ply orientation of the composite laminate. The maximum bound width or ranges of first three natural frequencies for both angle-ply ($45^\circ/-45^\circ/45^\circ/-45^\circ$) and cross-ply ($0^\circ/90^\circ/0^\circ/90^\circ$) composite cantilever plate are consistently observed (Fig. 8) for combined variation of ply-orientation angle, elastic modulus, mass density and shear modulus [$\theta, E_1, \rho, G_{12}(\tilde{\omega}_\alpha)$] irrespective of fuzzy α -cut except for $\alpha = 1$ which indicates the respective deterministic value of natural frequencies. For the cases of only variation of input parameters [i.e., $\theta(\tilde{\omega}_\alpha), E_1(\tilde{\omega}_\alpha), \rho(\tilde{\omega}_\alpha)$ and $G_{12}(\tilde{\omega}_\alpha)$], the maximum range of frequency is identified for first and third modes at different α -cuts of the only variation of ply-orientation angle [$\theta(\tilde{\omega}_\alpha)$] for angle-ply ($45^\circ/-45^\circ/45^\circ/-45^\circ$) composite plate. For cross-ply ($0^\circ/90^\circ/0^\circ/90^\circ$) composite plate, the ranges of fundamental natural frequencies are in the order as $E_1(\tilde{\omega}_\alpha) > \rho(\tilde{\omega}_\alpha) > \theta(\tilde{\omega}_\alpha) > G_{12}(\tilde{\omega}_\alpha)$ (in case of only variation of any single input parameter)

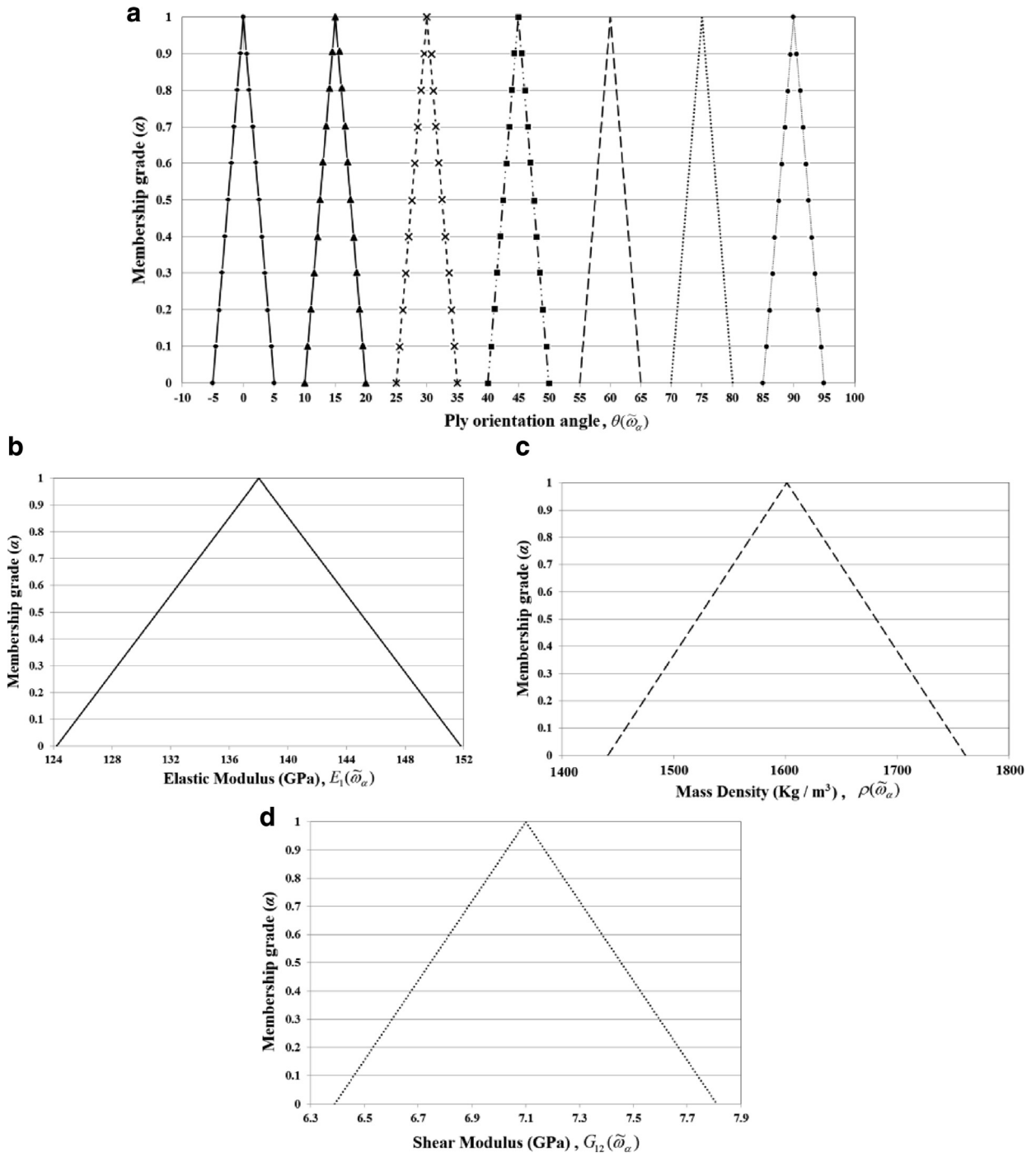

Fig. 5. Variation of four fuzzy input variables namely, ply-orientation angle, elastic modulus, mass density and shear modulus for four layered graphite-epoxy angle-ply ($|\theta^\circ|-\theta^\circ|-\theta^\circ|$) composite cantilever plate considering $E_1 = 138$ GPa, $E_2 = 8.9$ GPa, $G_{12} = G_{13} = 7.1$ GPa, $G_{23} = 2.84$ GPa, $\rho = 1600$ Kg/m³, $t = 0.006$ m, $\nu = 0.3$.

invariant to fuzzy α -cut. It is also noted that $G_{12}(\tilde{\omega}_\alpha)$ has negligible effect on variation of fundamental natural frequency for cross-ply composite plate. In contrast, the ranges of second and third natural frequencies of cross-ply composite plates are in the order as $\rho(\tilde{\omega}_\alpha) > E_1(\tilde{\omega}_\alpha) > G_{12}(\tilde{\omega}_\alpha) > \theta(\tilde{\omega}_\alpha)$ (in case of only variation of any single input parameter) irrespective of α -cut. Interestingly, the least influence of $\theta(\tilde{\omega}_\alpha)$ on range of natural frequencies in cross-ply is observed in case of cross-ply composite laminate while $G_{12}(\tilde{\omega}_\alpha)$ is found to be least effective on range of first three natural frequencies for angle-ply composite plates.

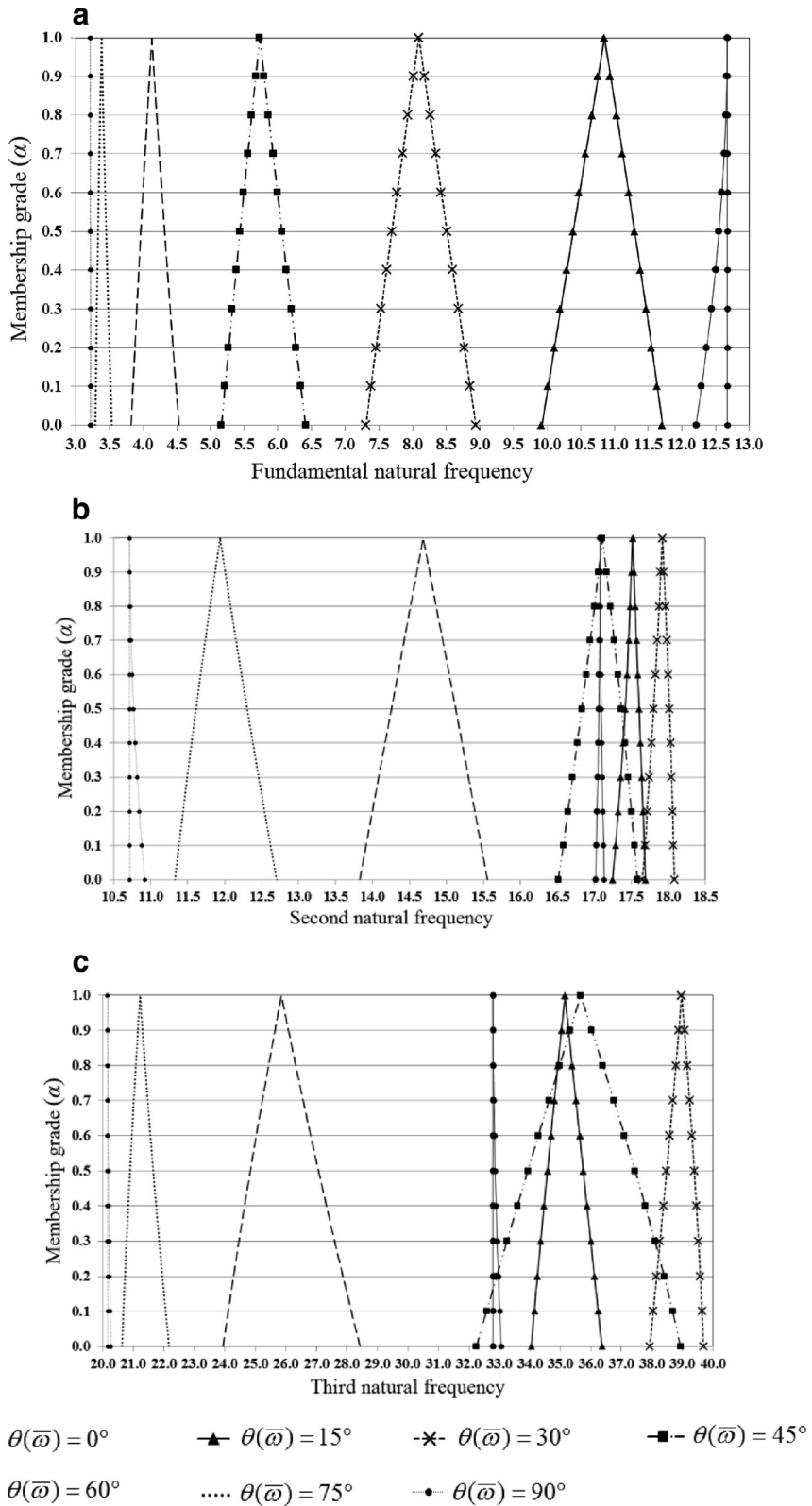

Fig. 6. Variation of first three natural frequencies due to only variation in ply-orientation angle for four layered graphite–epoxy angle-ply (θ° – θ° – θ° – θ°) composite cantilever plate considering $E_1 = 138$ GPa, $E_2 = 8.9$ GPa, $G_{12} = G_{13} = 7.1$ GPa, $G_{23} = 2.84$ GPa, $\rho = 1600$ Kg/m³, $t = 0.006$ m, $\nu = 0.3$, $n_v = 4$.

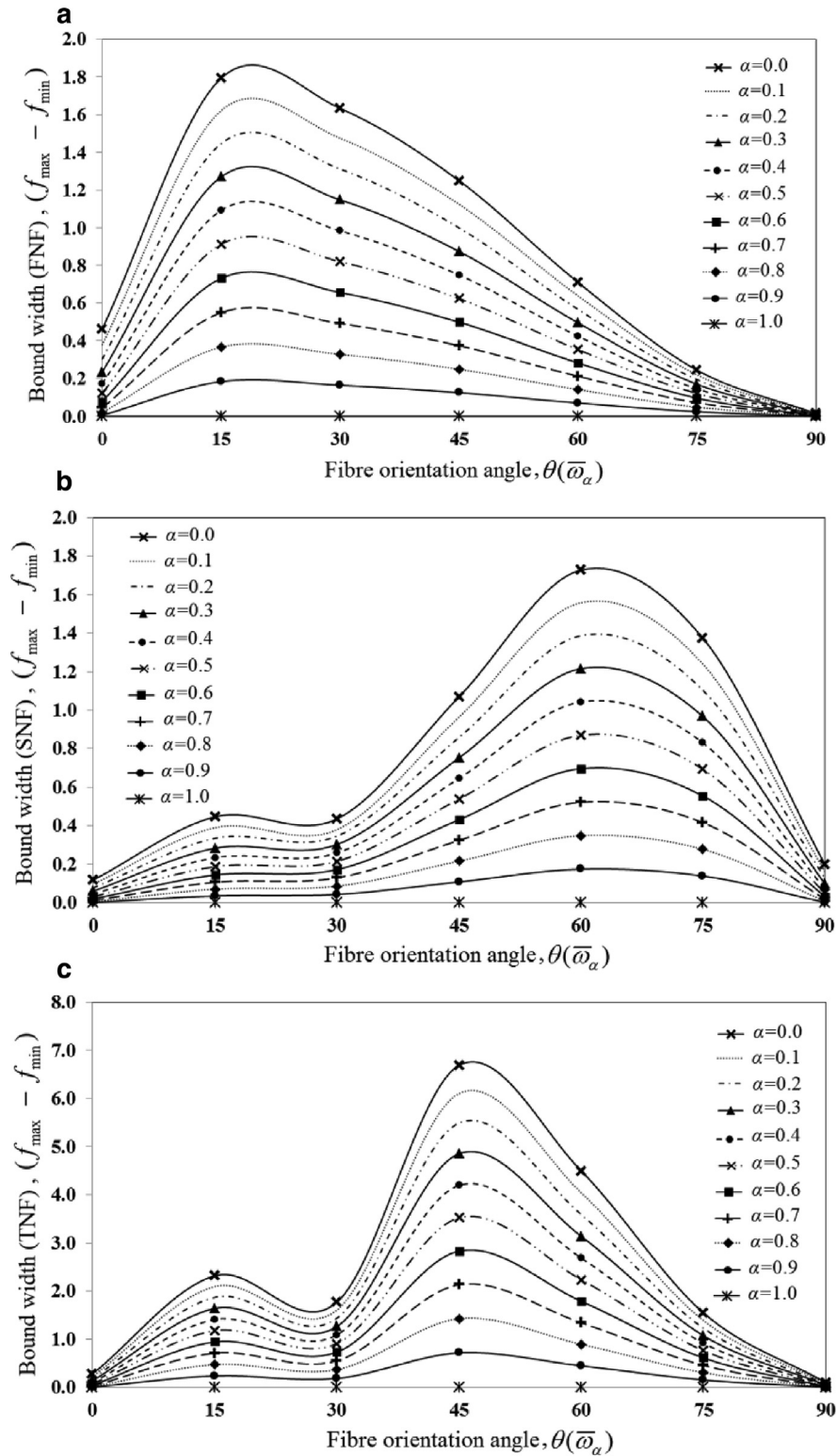

Fig. 7. Bound width of first three natural frequencies with respect to fiber orientation angle due to only variation of ply-orientation angle for four layered graphite–epoxy angle-ply ($\theta^\circ/-\theta^\circ/\theta^\circ/-\theta^\circ$) composite cantilever plate considering $E_1 = 138$ GPa, $E_2 = 8.9$ GPa, $G_{12} = G_{13} = 7.1$ GPa, $G_{23} = 2.84$ GPa, $\rho = 1600$ Kg/m³, $t = 0.006$ m, $\nu = 0.3$, $n_v = 4$. (FNF–Fundamental natural frequency, SNF–Second natural frequency, TNF–Third natural frequency).

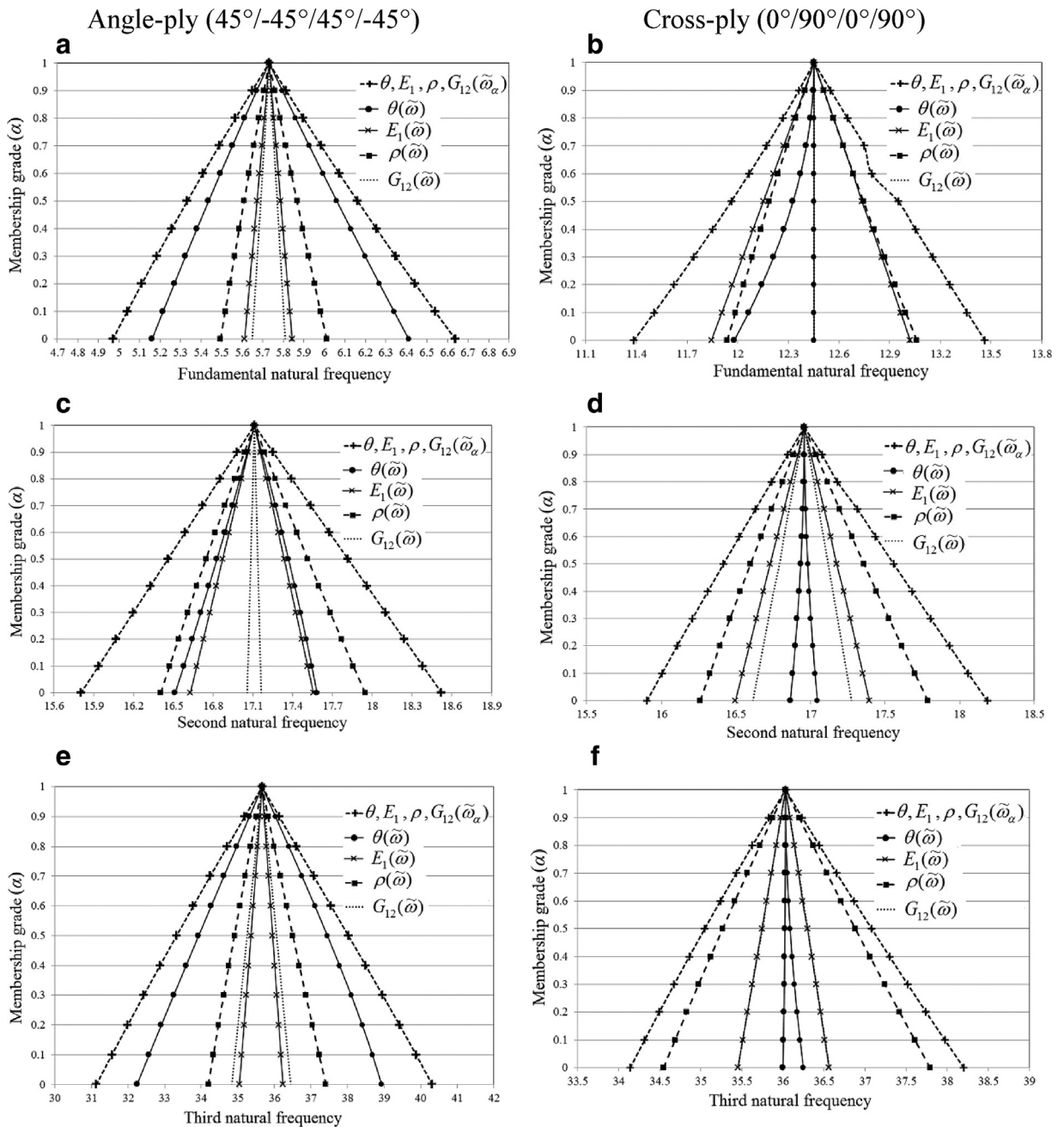

Fig. 8. Variation of first three natural frequencies due to only variation of ply-orientation angle, elastic modulus, shear modulus and mass density and combined variation for graphite–epoxy angle-ply (45°/–45°/45°/–45°) and cross-ply (0°/90°/0°/90°) composite cantilever plate considering $E_1 = 138$ GPa, $E_2 = 8.9$ GPa, $G_{12} = G_{13} = 7.1$ GPa, $G_{23} = 2.84$ GPa, $\rho = 1600$ Kg/m³, $t = 0.006$ m, $\nu = 0.3$, $n_v = 4$ (for individual cases) and $n_v = 16$ (for combined case).

The comparative studies for angle-ply (45°/–45°/45°/–45°) and cross-ply (0°/90°/0°/90°) composite cantilever plates with respect to maximum and minimum values of first three natural frequencies at $\alpha = 0$ and 0.5 are carried out using global optimization (GO) approach and present fuzzy Gram–Schmidt polynomial chaos expansion (GSPCE) approach as furnished in Table 3 (individual case) and Table 4 (combined case), respectively. The computational time required in the proposed approach is observed to be around (1/156) times (for individual variation of inputs) and (1/78) times (for combined variation of inputs) of global optimization approach. It should be noted that, standard Genetic Algorithm (GA) is used for global optimization. GA has been found as one of the powerful and robust global optimization method that search for global solutions to problems that contain multiple maxima or minima. Once the PCE model is formed that is capable of representing the entire design domain, global optimization algorithms like GA can be efficiently applied. For the purpose of comparison, results obtained using classical

Table 3

Comparative study between global optimization (GO) approach and present fuzzy GSPCE and CPCE approach for α -cut = 0 and 0.5 with respect to variation of first three natural frequencies due to only variation of ply-orientation angle [$\theta(\tilde{\omega}_\alpha)$] for four layered graphite–epoxy angle-ply ($45^\circ/-45^\circ/45^\circ/-45^\circ$) and cross-ply ($0^\circ/90^\circ/0^\circ/90^\circ$) composite cantilever plate considering $E_1 = 138$ GPa, $E_2 = 8.9$ GPa, $G_{12} = G_{13} = 7.1$ GPa, $G_{23} = 2.84$ GPa, $\rho = 1600$ Kg/m³, $t = 0.006$ m, $\nu = 0.3$, $n_v = 4$ (in each cases) (FNF – Fundamental natural frequency, SNF – Second natural frequency, TNF – Third natural frequency, GSPCE– Gram–Schmidt polynomial chaos expansion, CPCE– Classical polynomial chaos expansion).

α - cut	Method	Angle-ply						Cross-ply					
		FNF		SNF		TNF		FNF		SNF		TNF	
		Max	Min	Max	Min	Max	Min	Max	Min	Max	Min	Max	Min
0	GO Approach	6.4111	5.1612	17.5827	16.5128	38.9342	32.2457	12.4517	11.9790	17.0457	16.8653	36.2476	36.0004
	Fuzzy GSPCE Approach	6.4252	5.1047	17.5887	16.4475	39.0405	31.8866	12.4495	11.9711	17.0625	16.8604	36.2891	35.9981
	% deviation	-0.22%	1.09%	-0.03%	0.40%	-0.27%	1.11%	0.02%	0.07%	-0.10%	0.03%	-0.11%	0.01%
	Fuzzy CPCE Approach	6.3212	5.2456	17.6324	16.3212	38.7645	32.4423	12.2314	11.8974	17.2301	16.6329	36.112	36.1432
0.5	% deviation	1.40%	-1.64%	-0.28%	1.16%	0.44%	-0.61%	1.77%	0.68%	-1.08%	1.38%	0.37%	-0.40%
	GO Approach	6.0607	5.4366	17.3675	16.8286	37.4502	33.9303	12.4517	12.3274	16.9816	16.9345	36.0859	36.0230
	Fuzzy GSPCE Approach	6.0719	5.4184	17.3710	16.8120	37.4868	33.8297	12.4515	12.3258	16.9850	16.9336	36.0929	36.0224
	% deviation	-0.18%	0.33%	-0.02%	0.10%	-0.10%	0.30%	0.00%	0.01%	-0.02%	0.01%	-0.02%	0.00%
	Fuzzy CPCE Approach	6.1265	5.3254	17.4235	16.6923	37.4321	33.7988	12.5978	12.2312	16.8765	16.8865	36.1238	36.1867
	% deviation	-1.09%	2.05%	-0.32%	0.81%	0.05%	0.39%	-1.17%	0.78%	0.62%	0.28%	-0.11%	-0.45%

Table 4

Comparative study between global optimization (GO) approach and fuzzy GSPCE and CPCE approach for α -cut = 0 and 0.5 with respect to variation of first three natural frequencies due to combined variation of ply-orientation angle, elastic modulus, shear modulus and mass density for four layered graphite–epoxy angle-ply ($45^\circ/-45^\circ/45^\circ/-45^\circ$) and cross-ply ($0^\circ/90^\circ/0^\circ/90^\circ$) composite cantilever plate considering $E_1 = 138$ GPa, $E_2 = 8.9$ GPa, $G_{12} = G_{13} = 7.1$ GPa, $G_{23} = 2.84$ GPa, $\rho = 1600$ Kg/m³, $t = 0.006$ m, $\nu = 0.3$, $n_v = 16$ (FNF – Fundamental natural frequency, SNF – Second natural frequency, TNF – Third natural frequency, GSPCE– Gram–Schmidt polynomial chaos expansion, CPCE– Classical polynomial chaos expansion).

α - Method cut	Angle-ply						Cross-ply						
	FNF		SNF		TNF		FNF		SNF		TNF		
	Max	Min	Max	Min	Max	Min	Max	Min	Max	Min	Max	Min	
0	GO Approach	6.6376	4.9701	18.5214	15.8036	40.3142	31.1363	13.4631	11.3848	18.1851	15.9033	38.1998	34.1395
	Fuzzy GSPCE Approach	6.6504	4.8989	18.6893	15.7116	40.6208	30.5514	13.4791	11.1632	18.2047	15.6801	38.4355	33.9291
	% deviation	-0.19%	1.43%	-0.91%	0.58%	-0.76%	1.88%	-0.12%	1.95%	-0.11%	1.40%	-0.62%	0.62%
	Fuzzy CPCE Approach	6.6120	4.8932	18.8432	15.6543	40.4532	31.0876	13.3343	11.4532	18.0876	15.7643	38.3452	34.0054
% deviation	0.38%	1.57%	-1.71%	0.95%	-0.34%	0.15%	0.96%	-0.59%	0.54%	0.88%	-0.38%	0.39%	
0.5	GO Approach	6.1616	5.3326	17.8166	16.4582	38.0229	33.3266	12.9504	11.9618	17.5578	16.4166	37.0791	35.0451
	Fuzzy GSPCE Approach	6.1996	5.3000	17.9752	16.1847	38.0000	33.0011	12.9907	11.9000	17.5889	16.2929	37.2481	34.9710
	% deviation	-0.62%	0.61%	-0.89%	1.66%	0.06%	0.98%	-0.31%	0.52%	-0.18%	0.75%	-0.46%	0.21%
	Fuzzy CPCE Approach	6.1494	5.2656	18.2107	16.7285	38.3598	33.1743	12.7521	11.8201	17.7572	16.3433	37.674	35.564
% deviation	0.19%	1.25%	-2.21%	-1.64%	-0.88%	0.45%	1.55%	1.19%	-1.12%	0.44%	-1.57%	-1.46%	

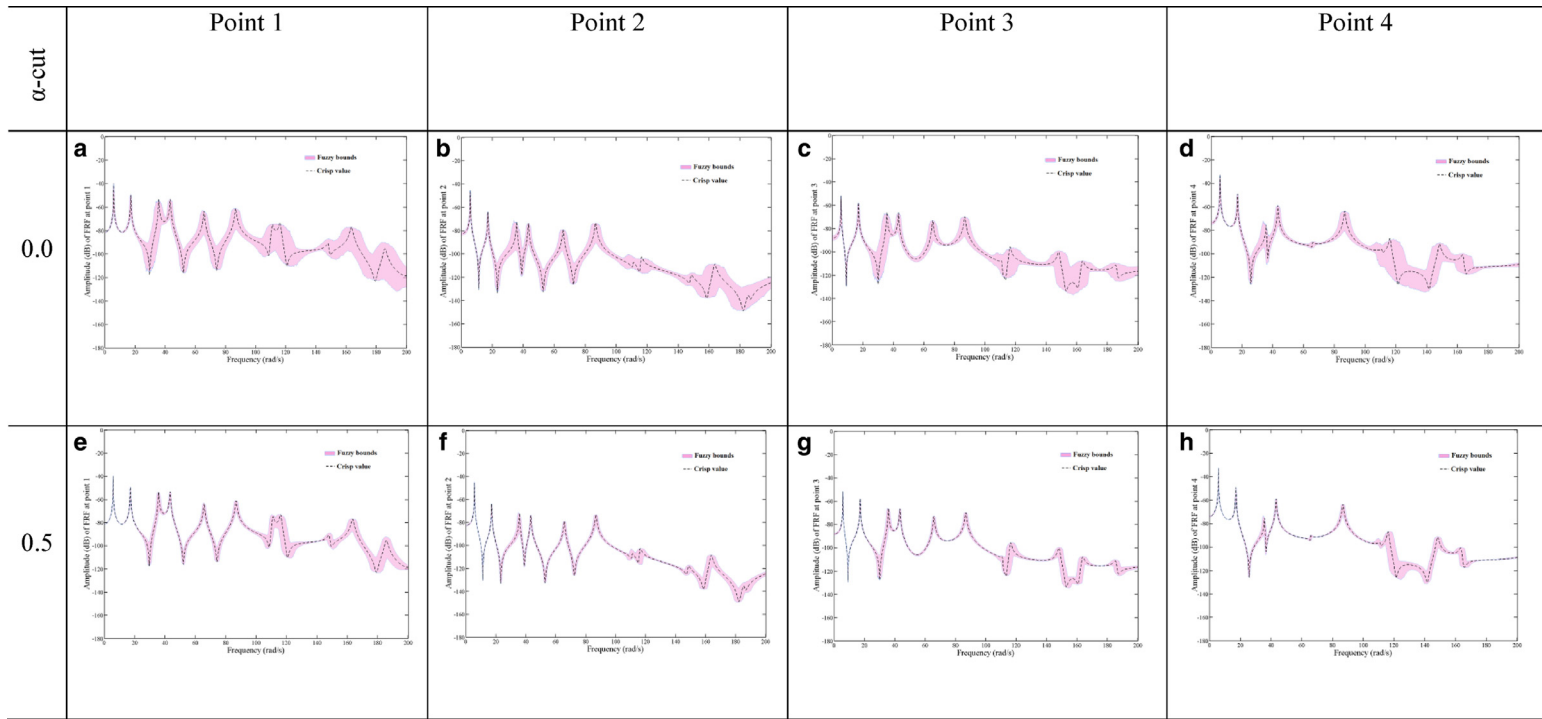

Fig. 9. (a-h) Frequency response function plot with reference to Fig. 1(b), indicating simulation bound, simulation mean and deterministic values for combined stochasticity in ply-orientation angle, elastic modulus, shear modulus and mass density of angle-ply (45°/–45°/45°/–45°) composite cantilever plate considering $E_1 = 138$ GPa, $E_2 = 8.9$ GPa, $G_{12} = G_{13} = 7.1$ GPa, $G_{23} = 2.84$ GPa, $\rho = 1600$ Kg/m³, $t = 0.006$ m, $\nu = 0.3$, $n_v = 16$.

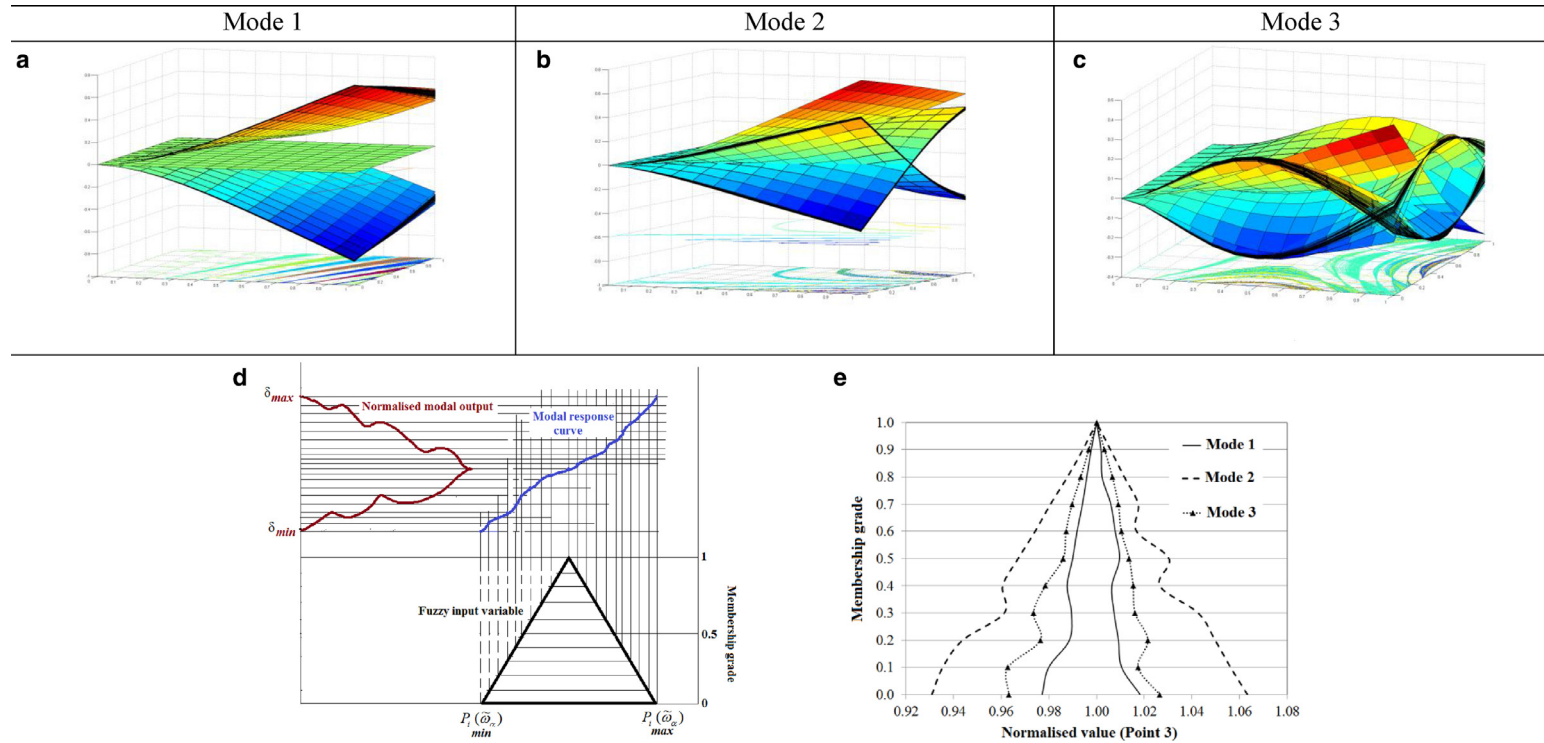

Fig. 10. (a-c) Modeshape diagram and (d-e) normalized component of mode at point 3 (point 3 furnished in Fig. 1) of first three modes due to combined stochasticity in ply-orientation angle, elastic modulus, shear modulus and mass density for four layered graphite-epoxy angle-ply ($45^\circ/-45^\circ/45^\circ/-45^\circ$) composite cantilever plate at α -cut = 0 considering $E_1 = 138$ GPa, $E_2 = 8.9$ GPa, $G_{12} = G_{13} = 7.1$ GPa, $G_{23} = 2.84$ GPa, $\rho = 1600$ Kg/m³, $t = 0.006$ m, $\nu = 0.3$, $n_v = 16$.

polynomial chaos expansion (CPCE) are also furnished in Tables 3 and 4 that indicate that there is not much difference between the maximum and minimum values of responses following fuzzy GSPCE and CPCE approach. The deviation or difference between these two results corroborates the fact that the present PCE approach is accurate and computationally efficient. The frequency response function (FRF) plot is furnished in Fig. 9 indicating simulation bound, simulation mean and deterministic values corresponding to different α -cut for combined stochasticity in ply-orientation angle, elastic modulus, shear modulus and mass density of angle-ply ($45^\circ/-45^\circ/45^\circ/-45^\circ$) composite cantilever plate. The maximum simulation bound of frequency responses due to combined variation of input parameters is found at $\alpha = 0$. As the value of α -cut increases the simulation bound of frequency response function also decreases and finally at $\alpha = 1$, it shows the deterministic value without any simulation bound as expected. For a given amount of fuzziness in the input parameters, more changes in the fuzzy output quantities are observed in the higher frequency ranges. Fig. 10(a-c) presents the representative modeshapes of the first three natural frequencies considering combined fuzzy-variation in ply orientation angle, elastic modulus (longitudinal), mass density and shear modulus. The fundamental natural frequency corresponds to first spanwise bending and as the mode increases the combined effect of torsion and spanwise bending is predominantly observed for the second and third modes. The normalized component of mode at point 3 (as indicated in Fig. 1) of first three modes due to combined variation of ply-orientation angle, elastic modulus, shear modulus and mass density for four layered graphite–epoxy angle-ply composite cantilever plate for different α -cut are furnished in Fig. 10(d-e). The normal component of first three modes portrays the representative variation of fuzzy mode shapes corresponding to different membership grades. As it is illustrated in Fig. 10(e), even though the input fuzzy numbers are defined by a triangular membership function, the resulting membership functions of output fuzzy numbers may not have a triangular shape.

5. Conclusions

The novelty of present study includes the hybridization of fuzzy PCE approach based uncertainty propagation with laminated composite plate. The uncertainty quantification of natural frequency and the frequency response functions with fuzzy variables are derived implicitly using finite element method. The present study proposes a new approach to predict the uncertainty bounds of first three natural frequencies of composite cantilever plates with fuzzy-variation in ply orientation and material properties (such as elastic modulus, mass density, shear modulus) in an efficient manner. The computational time and cost is reduced by using the present fuzzy PCE approach compared to global optimization method. The maximum ranges of first three natural frequencies are consistently found for combined variation of ply-orientation angle, elastic modulus, mass density and shear modulus compared to individual variation of any input parameter irrespective of fuzzy α -cut. Due to combined variation of input parameters, the maximum simulation bound of frequency response function is obtained at $\alpha = 0$ which decreases with increase of fuzzy α -cut and it shows the deterministic value without any simulation bound finally at $\alpha = 1$. The fundamental natural frequency corresponds to first spanwise bending and as the mode increases the combined effect of torsion and bending is predominantly observed for the second and three modes. The normal component of first three modes are portrayed as the representative variation of fuzzy mode shapes corresponding to different membership grades. The present study can be extended for future research to deal with more complex system considering a large number of fuzzy variables.

References

- [1] A. Haldar, S. Mahadevan, Probabilistic Structural Mechanics Handbook, Chapman & Hall, 1993.
- [2] R. Ghanem, P.D. Spanos, Stochastic finite elements: A spectral approach, Springer-Verlag, New York, 1991.
- [3] B. Pascual, S. Adhikari, Combined parametric-nonparametric uncertainty quantification using random matrix theory and polynomial chaos expansion, Comput. Struct. 112–113 (12) (2012) 364–379.
- [4] Nian-Zhong Chen, C. Guedes Soares, Spectral stochastic finite element analysis for laminated composite plates, Comput. Methods Appl. Mech. Eng. 197 (51–52) (2008) 4830–4839.
- [5] S. Dey, T. Mukhopadhyay, S. Adhikari, Stochastic free vibration analyzes of composite doubly curved shells - A Kriging model approach, Compos. Part B: eng. 70 (2015) 99–112.
- [6] S. Dey, T. Mukhopadhyay, S. Adhikari, Stochastic free vibration analysis of angle-ply composite plates - A RS-HDMR approach, Compos. Struct. 122 (2014) 526–536 2015.
- [7] S. Dey, T. Mukhopadhyay, H.H. Khodaparast, S. Adhikari, Stochastic natural frequency of composite conical shells, Acta Mech. 226 (8) (2015) 2537–2553.
- [8] S. Dey, T. Mukhopadhyay, H.H. Khodaparast, P. Kerfriden, S. Adhikari, Rotational and ply-level uncertainty in response of composite shallow conical shells, Compos. Struct. 131 (2015) 594–605.
- [9] S. Dey, T. Mukhopadhyay, S.K. Sahu, G. Li, H. Rabitz, S. Adhikari, Thermal uncertainty quantification in frequency responses of laminated composite plates, Compos. Part B: eng. 80 (2015) 186–197.
- [10] B. Mace, K. Worden, G. Manson, Uncertainty in structural dynamics, J. Sound Vib. 288 (3) (2005) 423–429.
- [11] D. Moens, M. Hanss, Non-probabilistic finite element analysis for parametric uncertainty treatment in applied mechanics: Recent advances, Finite Elem. Anal. Des. 47 (1) (2011) 4–16.
- [12] L.A. Zadeh, Concept of a linguistic variable and its application to approximate reasoning-I, Inf. Sci. 8 (3) (1975) 199–249.
- [13] B. Möller, Michael Beer, Fuzzy Randomness - Uncertainty in Civil Engineering and Computational Mechanics, Springer, Berlin, 2004.
- [14] Yong Denga, Yuxin Chen, Yajuan Zhang, Sankaran Mahadevan, Fuzzy Dijkstra algorithm for shortest path problem under uncertain environment, Appl. Soft Comput. 12 (3) (2012) 1231–1237.
- [15] R.E. Moore, Interval Analysis, Prentice-Hall, Englewood Cliffs, NJ, USA, 1966.
- [16] D. Degrauwe, G. Lombaert, G.D. Roeck, Improving interval analysis in finite element calculations by means of affine arithmetic, Comput. Struct. 88 (3–4) (2010) 247–254.
- [17] Z. Qiu, X. Wang, M. Friswell, Eigenvalue bounds of structures with uncertain-but-bounded parameters, J. Sound Vib. 282 (1–2) (2005) 297–312.
- [18] B. Lallemand, G. Plessis, T. Tison, P. Level, Neumann expansion for fuzzy finite element analysis, Eng. Comput. 16 (5) (1999) 572–583.
- [19] M. Hanss, The transformation method for the simulation and analysis of systems with uncertain parameters, Fuzzy Sets Syst 130 (3) (2002) 277–289.
- [20] M. DeMunck, D. Moens, W. Desmet, D. Vandepitte, A response surface based optimization algorithm for the calculation of fuzzy envelope FRFs of models with uncertain properties, Comput. Struct. 86 (10) (2008) 1080–1092.

- [21] Ivo Babuška, Renato S. Silva, Dealing with uncertainties in engineering problems using only available data, *Comput. Methods Appl. Mech. Eng.* 270 (2014) 57–75.
- [22] S.S. Rao, K.K. Annamdas, Evidence-based fuzzy approach for the safety analysis of uncertain systems, *AIAA J.* 46 (9) (2008) 2383–2387.
- [23] Achchhe Lal, B.N. Singh, Effect of random system properties on bending response of thermo-mechanically loaded laminated composite plates, *Appl. Math. Model.* 35 (12) (2011) 5618–5635.
- [24] M. Diaz-Madroño, D. Peidro, J. Mula, A fuzzy optimization approach for procurement transport operational planning in an automobile supply chain, *Appl. Math. Model.* 38 (23) (2014) 5705–5725.
- [25] K. Umesh, R. Ganguli, Material uncertainty effect on vibration control of smart composite plate using polynomial chaos expansion, *Mech. Adv. Mater. Struct.* 20 (7) (2013) 580–591.
- [26] R. Chowdhury, S. Adhikari, Fuzzy parametric uncertainty analysis of linear dynamical systems: a surrogate modeling approach, *Mech. Syst. Signal Process.* 32 (10) (2012) 5–17.
- [27] A. Muc, P. Kędziora, A fuzzy set analysis for a fracture and fatigue damage response of composite materials, *Compos. Struct.* 54 (2–3) (2001) 283–287.
- [28] Yu-Te Chang, Shih-Ju Ho, Bor-Sen Chen, Robust stabilization design of nonlinear stochastic partial differential systems: fuzzy approach, *Fuzzy Sets Syst.* 248 (2014) 61–85.
- [29] F. Altmann, J.U. Sickert, V. Mechtcherine, M. Kaliske, A fuzzy-probabilistic durability concept for strain-hardening cement-based composites (SHCCs) exposed to chlorides: part 1: concept development, *Cem. Concr. Compos.* 34 (6) (2012) 754–762.
- [30] N.S. Arunraj, S. Mandal, J. Maiti, Modeling uncertainty in risk assessment: an integrated approach with fuzzy set theory and Monte Carlo simulation, *Accid. Anal. Prev.* 55 (2013) 242–255.
- [31] M. Karbhari Vistasp, Matthias Stein, Fuzzy logic based approach to FRP retrofit of columns, *Compos. Part B: eng.* 38 (5–6) (2007) 651–673.
- [32] T. Rajmohan, K. Palanikumar, S. Prakash, Grey-fuzzy algorithm to optimize machining parameters in drilling of hybrid metal matrix composites, *Compos. Part B: eng.* 50 (2013) 297–308.
- [33] Hamid Bohlooli, Ali Nazari, Gholamreza Khalaj, Mohammad Mehdi Kaykha, Shadi Riahi, Experimental investigations and fuzzy logic modeling of compressive strength of geopolymers with seeded fly ash and rice husk bark ash, *Compos. Part B: eng.* 43 (3) (2012) 1293–1301.
- [34] L.A. Zadeh, Fuzzy sets, *Inf. Control* 8 (3) (1965) 338–353.
- [35] M. Hanss, K. Willner, A fuzzy arithmetical approach to the solution of finite element problems with uncertain parameters, *Mech. Res. Commun.* 27 (3) (2000) 257–272.
- [36] J.A.S. Witteveen, H. Bijl, Modeling arbitrary uncertainties using Gram–Schmidt polynomial chaos, *AIAA paper*, AIAA 2006-896, in: 44th AIAA Aerospace Sciences Meeting and Exhibit, Reno, Nevada, USA, 9–12 January 2006.
- [37] S. Adhikari, H. Haddad Khodaparast, A spectral approach for fuzzy uncertainty propagation in finite element analysis, *Fuzzy Sets Syst.* 243 (2014) 1–24.
- [38] D.C. Montgomery, Design and analysis of experiments, J. Wiley and Sons, N.J., 1991.
- [39] T. Mukhopadhyay, T.K. Dey, S. Dey, A. Chakrabarti, Optimization of fiber reinforced polymer web core bridge deck – A hybrid approach, *Struct. Eng. Int.* 25 (2) (2015) 173–183.
- [40] S. Dey, A. Karmakar, Free vibration analyses of multiple delaminated angle-ply composite conical shells – A finite element approach, *Compos. Struct.* 94 (7) (2012) 2188–2196.
- [41] H. Haddad Khodaparast, Y. Govers, S. Adhikari, M. Link, M.I. Friswell, J.E. Mottershead, J. Sienz, Fuzzy Model Updating and its Application to the DLR AIRMOD Test Structure, USD 2014, Leuven, Belgium, 15–17 September 2014, pp. 4631–4644.
- [42] K.J. Bathe, Finite Element Procedures in Engineering Analysis, PHI, New Delhi, 1990.
- [43] M.S. Qatu, A.W. Leissa, Natural frequencies for cantilevered doubly-curved laminated composite shallow shells, *Compos. Struct.* 17 (1991) 227–255.
- [44] M. Hanss, Applied Fuzzy Arithmetic – An Introduction with Engineering Applications, Springer Publication, New York, 2005 ISBN 3-540-24201-5.
- [45] M.S. Qatu, A.W. Leissa, Vibration studies for laminated composite twisted cantilever plates, *Int. J. Mech. Sci.* 33 (11) (1991) 927–940.