

# Vibration energy harvesting in uncertain environments

S Adhikari<sup>1</sup>

<sup>1</sup>College of Engineering, Swansea University, Singleton Park, Swansea SA2 8PP, UK

City University, London



Swansea University  
Prifysgol Abertawe







## Collaborations

- Professor Mike Friswell and Dr Alexander Potrykus (Swansea University, UK).
- Professor Dan Inman (University of Michigan, USA)
- Professor Grzegorz Litak (University of Lublin, Poland).
- Professor Eric Jacquelin (University of Lyon, France)
- Professor S Narayanan and Dr S F Ali (IIT Madras, India).
- Highly multidisciplinary research area - multi-physics and more recently multi-scale approaches are used

## 1 Introduction

- Piezoelectric vibration energy harvesting
- The role of uncertainty

## 2 Single Degree of Freedom Electromechanical Models

- Linear systems
- Nonlinear systems

## 3 Optimal Energy Harvester Under Gaussian Excitation

- Circuit without an inductor
- Circuit with an inductor

## 4 Stochastic System Parameters

## 5 Nonlinear Energy Harvesting Under Random Excitations

- Equivalent linearisation approach
- Monte Carlo simulations
- Fokker-Planck equation analysis

## 6 Multiple-Degree-of-Freedom Energy Harvesters

## 7 Conclusions

## Piezoelectric vibration energy harvesting

- The harvesting of ambient vibration energy for use in powering low energy electronic devices has formed the focus of much recent research.
- Of the published results that focus on the piezoelectric effect as the transduction method, most have focused on harvesting using cantilever beams and on single frequency ambient energy, i.e., resonance based energy harvesting. Several authors have proposed methods to optimize the parameters of the system to maximize the harvested energy.
- Some authors have considered energy harvesting under wide band excitation.

## Why uncertainty is important for energy harvesting?

- In the context of energy harvesting from ambient vibration, the **input excitation may not be always known exactly**.
- There may be uncertainties associated with the numerical values considered for various parameters of the harvester. This might arise, for example, due to the **difference between the true values and the assumed values**.
- If there are several nominally identical energy harvesters to be manufactured, there may be **genuine parametric variability** within the ensemble.
- Any **deviations** from the assumed excitation may result an optimally designed harvester to become sub-optimal.

## Types of uncertainty

Suppose the set of coupled equations for energy harvesting:

$$\mathcal{L}\{\mathbf{u}(t)\} = \mathbf{f}(t) \quad (1)$$

### Uncertainty in the input excitations

- For this case in general  $\mathbf{f}(t)$  is a random function of time. Such functions are called random processes.
- $\mathbf{f}(t)$  can be Gaussian/non-Gaussian stationary or non-stationary random processes

### Uncertainty in the system

- The operator  $\mathcal{L}\{\bullet\}$  is in general a function of parameters  $\theta_1, \theta_2, \dots, \theta_n \in \mathbb{R}$ .
- The uncertainty in the system can be characterised by the joint probability density function  $p_{\theta_1, \theta_2, \dots, \theta_n}(\theta_1, \theta_2, \dots, \theta_n)$ .



## SDOF electromechanical models

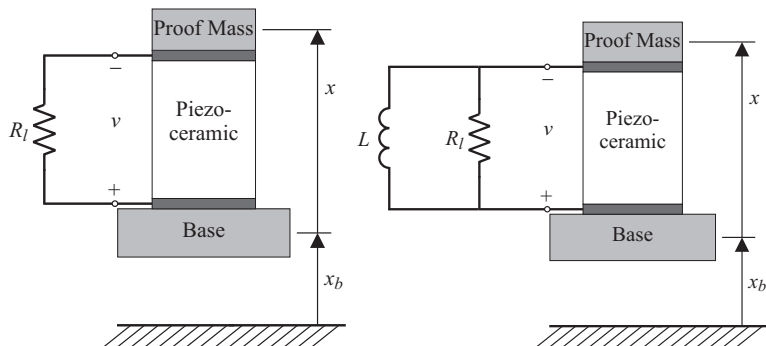

Schematic diagrams of piezoelectric energy harvesters with two different harvesting circuits. (a) Harvesting circuit without an inductor, (b) Harvesting circuit with an inductor.

## Governing equations

For the harvesting circuit **without** an inductor, the coupled electromechanical behavior can be expressed by the linear ordinary differential equations

$$m\ddot{x}(t) + c\dot{x}(t) + kx(t) - \theta v(t) = f(t) \quad (2)$$

$$\theta\dot{x}(t) + C_p\dot{v}(t) + \frac{1}{R_l}v(t) = 0 \quad (3)$$

For the harvesting circuit **with** an inductor, the electrical equation becomes

$$\theta\ddot{x}(t) + C_p\ddot{v}(t) + \frac{1}{R_l}\dot{v}(t) + \frac{1}{L}v(t) = 0 \quad (4)$$

## Simplified piezomagnetoelastic model

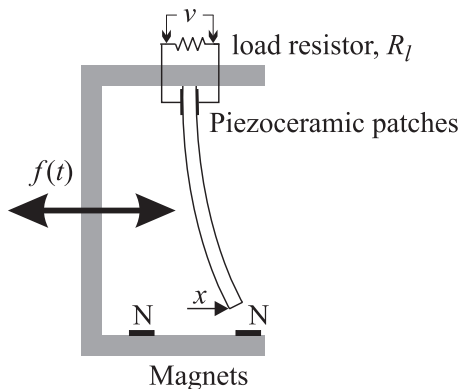

Schematic of the piezomagnetoelastic device. The beam system is also referred to as the 'Moon Beam'.

## Governing equations

- The nondimensional equations of motion for this system are

$$\ddot{x} + 2\zeta\dot{x} - \frac{1}{2}x(1 - x^2) - \chi v = f(t), \quad (5)$$

$$\dot{v} + \lambda v + \kappa\dot{x} = 0, \quad (6)$$

- Here  $x$  is the dimensionless transverse displacement of the beam tip,  $v$  is the dimensionless voltage across the load resistor,  $\chi$  is the dimensionless piezoelectric coupling term in the mechanical equation,  $\kappa$  is the dimensionless piezoelectric coupling term in the electrical equation,  $\lambda \propto 1/R_l C_p$  is the reciprocal of the dimensionless time constant of the electrical circuit,  $R_l$  is the load resistance, and  $C_p$  is the capacitance of the piezoelectric material.
- The force  $f(t)$  is proportional to the base acceleration on the device.
- If we consider the inductor, then the second equation will be  $\ddot{v} + \lambda\dot{v} + \beta v + \kappa\ddot{x} = 0$ .

## Possible physically realistic cases

Depending on the system and the excitation, several cases are possible:

- Linear system excited by harmonic excitation
- Linear system excited by stochastic excitation
- Linear stochastic system excited by harmonic/stochastic excitation
- Nonlinear system excited by harmonic excitation
- Nonlinear system excited by stochastic excitation
- Nonlinear stochastic system excited by harmonic/stochastic excitation
- Multiple degree of freedom vibration energy harvesters

This talk is focused on application of random vibration theory to various energy harvesting problems

## Circuit without an inductor

Our equations:

$$m\ddot{x}(t) + c\dot{x}(t) + kx(t) - \theta v(t) = -m\ddot{x}_b(t) \quad (7)$$

$$\theta\dot{x}(t) + C_p\dot{v}(t) + \frac{1}{R_l}v(t) = 0 \quad (8)$$

Transforming both the equations into the frequency domain and dividing the first equation by  $m$  and the second equation by  $C_p$  we obtain

$$(-\omega^2 + 2i\omega\zeta\omega_n + \omega_n^2) X(\omega) - \frac{\theta}{m} V(\omega) = \omega^2 X_b(\omega) \quad (9)$$

$$i\omega \frac{\theta}{C_p} X(\omega) + \left( i\omega + \frac{1}{C_p R_l} \right) V(\omega) = 0 \quad (10)$$

## Circuit without an inductor

The natural frequency of the harvester,  $\omega_n$ , and the damping factor,  $\zeta$ , are defined as

$$\omega_n = \sqrt{\frac{k}{m}} \quad \text{and} \quad \zeta = \frac{c}{2m\omega_n}. \quad (11)$$

Dividing the preceding equations by  $\omega_n$  and writing in matrix form one has

$$\begin{bmatrix} (1 - \Omega^2) + 2i\Omega\zeta & -\frac{\theta}{k} \\ i\Omega\frac{\alpha\theta}{C_p} & (i\Omega\alpha + 1) \end{bmatrix} \begin{Bmatrix} X \\ V \end{Bmatrix} = \begin{Bmatrix} \Omega^2 X_b \\ 0 \end{Bmatrix}, \quad (12)$$

where the dimensionless frequency and dimensionless time constant are defined as

$$\Omega = \frac{\omega}{\omega_n} \quad \text{and} \quad \alpha = \omega_n C_p R_l. \quad (13)$$

$\alpha$  is the time constant of the first order electrical system, non-dimensionalized using the natural frequency of the mechanical system.

## Circuit without an inductor

Inverting the coefficient matrix, the displacement and voltage in the frequency domain can be obtained as

$$\begin{Bmatrix} X \\ V \end{Bmatrix} = \frac{1}{\Delta_1} \begin{bmatrix} (i\Omega\alpha+1) & \frac{\theta}{\kappa} \\ -i\Omega\frac{\alpha\theta}{C_p} & (1-\Omega^2)+2i\Omega\zeta \end{bmatrix} \begin{Bmatrix} \Omega^2 X_b \\ 0 \end{Bmatrix} = \begin{Bmatrix} (i\Omega\alpha+1)\Omega^2 X_b/\Delta_1 \\ -i\Omega^3\frac{\alpha\theta}{C_p} X_b/\Delta_1 \end{Bmatrix}, \quad (14)$$

where the determinant of the coefficient matrix is

$$\Delta_1(i\Omega) = (i\Omega)^3\alpha + (2\zeta\alpha + 1)(i\Omega)^2 + (\alpha + \kappa^2\alpha + 2\zeta)(i\Omega) + 1 \quad (15)$$

and the non-dimensional electromechanical coupling coefficient is

$$\kappa^2 = \frac{\theta^2}{kC_p}. \quad (16)$$



## Circuit without an inductor

### Mean power

The average harvested power due to the white-noise base acceleration with a circuit without an inductor can be obtained as

$$\begin{aligned} E[\tilde{P}] &= E\left[\frac{|V|^2}{(R_I \omega^4 \Phi_{x_b x_b})}\right] \\ &= \frac{\pi m \alpha \kappa^2}{(2 \zeta \alpha^2 + \alpha) \kappa^2 + 4 \zeta^2 \alpha + (2 \alpha^2 + 2) \zeta}. \end{aligned}$$

- From Equation (14) we obtain the voltage in the frequency domain as

$$V = \frac{-i\Omega^3 \frac{\alpha\theta}{C_p}}{\Delta_1(i\Omega)} X_b. \quad (17)$$

- We are interested in the mean of the normalized harvested power when the base acceleration is Gaussian white noise, that is  $|V|^2 / (R_I \omega^4 \Phi_{x_b x_b})$ .

## Circuit without an inductor

The spectral density of the acceleration  $\omega^4 \Phi_{x_b x_b}$  and is assumed to be constant. After some algebra, from Equation (17), the normalized power is

$$\tilde{P} = \frac{|V|^2}{(R_l \omega^4 \Phi_{x_b x_b})} = \frac{k \alpha \kappa^2}{\omega_n^3} \frac{\Omega^2}{\Delta_1(i\Omega) \Delta_1^*(i\Omega)}. \quad (18)$$

Using linear stationary random vibration theory, the average normalized power can be obtained as

$$E[\tilde{P}] = E\left[\frac{|V|^2}{(R_l \omega^4 \Phi_{x_b x_b})}\right] = \frac{k \alpha \kappa^2}{\omega_n^3} \int_{-\infty}^{\infty} \frac{\Omega^2}{\Delta_1(i\Omega) \Delta_1^*(i\Omega)} d\omega \quad (19)$$

From Equation (15) observe that  $\Delta_1(i\Omega)$  is a third order polynomial in  $(i\Omega)$ . Noting that  $d\omega = \omega_n d\Omega$  and from Equation (15), the average harvested power can be obtained from Equation (19) as

$$E[\tilde{P}] = E\left[\frac{|V|^2}{(R_l \omega^4 \Phi_{x_b x_b})}\right] = m \alpha \kappa^2 I^{(1)} \quad (20)$$

## Circuit without an inductor

$$J^{(1)} = \int_{-\infty}^{\infty} \frac{\Omega^2}{\Delta_1(i\Omega)\Delta_1^*(i\Omega)} d\Omega. \quad (21)$$

After some algebra, this integral can be evaluated as

$$J^{(1)} = \frac{\pi}{\alpha} \frac{\det \begin{bmatrix} 0 & 1 & 0 \\ -\alpha & \alpha + \kappa^2\alpha + 2\zeta & 0 \\ 0 & -2\zeta\alpha - 1 & 1 \end{bmatrix}}{\det \begin{bmatrix} 2\zeta\alpha + 1 & -1 & 0 \\ -\alpha & \alpha + \kappa^2\alpha + 2\zeta & 0 \\ 0 & -2\zeta\alpha - 1 & 1 \end{bmatrix}} \quad (22)$$

Combining this with Equation (20) we obtain the average harvested power due to white-noise base acceleration.

## Normalised mean power: numerical illustration

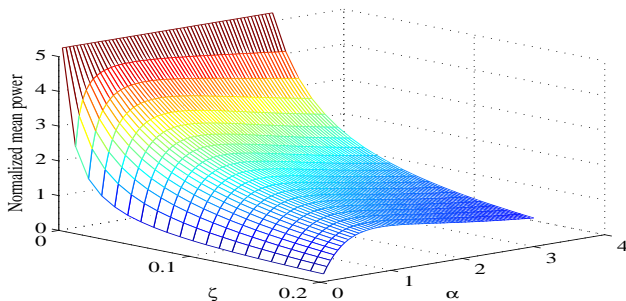

The normalized mean power of a harvester without an inductor as a function of  $\alpha$  and  $\zeta$ , with  $\kappa = 0.6$ . Maximizing the average power with respect to  $\alpha$  gives the condition  $\alpha^2 (1 + \kappa^2) = 1$  or in terms of physical quantities

$$R_I^2 C_p (k C_p + \theta^2) = m.$$

## Circuit with an inductor

The electrical equation becomes

$$\theta \ddot{x}(t) + C_p \ddot{v}(t) + \frac{1}{R_l} \dot{v}(t) + \frac{1}{L} v(t) = 0 \quad (23)$$

where  $L$  is the inductance of the circuit. Transforming equation (23) into the frequency domain and dividing by  $C_p \omega_n^2$  one has

$$-\Omega^2 \frac{\theta}{C_p} X + \left( -\Omega^2 + i\Omega \frac{1}{\alpha} + \frac{1}{\beta} \right) V = 0 \quad (24)$$

where the second dimensionless constant is defined as

$$\beta = \omega_n^2 L C_p, \quad (25)$$

Two equations can be written in a matrix form as

$$\begin{bmatrix} (1-\Omega^2) + 2i\Omega\zeta & -\frac{\theta}{k} \\ -\Omega^2 \frac{\alpha\beta\theta}{C_p} & \alpha(1-\beta\Omega^2) + i\Omega\beta \end{bmatrix} \begin{Bmatrix} X \\ V \end{Bmatrix} = \begin{Bmatrix} \Omega^2 X_b \\ 0 \end{Bmatrix}. \quad (26)$$

## Circuit with an inductor

Inverting the coefficient matrix, the displacement and voltage in the frequency domain can be obtained as

$$\begin{aligned} \begin{Bmatrix} X \\ V \end{Bmatrix} &= \frac{1}{\Delta_2} \begin{bmatrix} \alpha(1-\beta\Omega^2)+i\Omega\beta & \frac{\theta}{k} \\ \Omega^2 \frac{\alpha\beta\theta}{C_p} & (1-\Omega^2)+2i\Omega\zeta \end{bmatrix} \begin{Bmatrix} \Omega^2 X_b \\ 0 \end{Bmatrix} \\ &= \begin{Bmatrix} (\alpha(1-\beta\Omega^2)+i\Omega\beta)\Omega^2 X_b / \Delta_2 \\ \Omega^4 \frac{\alpha\beta\theta}{C_p} X_b / \Delta_2 \end{Bmatrix} \quad (27) \end{aligned}$$

where the determinant of the coefficient matrix is

$$\begin{aligned} \Delta_2(i\Omega) &= (i\Omega)^4 \beta \alpha + (2\zeta \beta \alpha + \beta) (i\Omega)^3 \\ &\quad + (\beta \alpha + \alpha + 2\zeta \beta + \kappa^2 \beta \alpha) (i\Omega)^2 + (\beta + 2\zeta \alpha) (i\Omega) + \alpha. \quad (28) \end{aligned}$$

## Circuit with an inductor

### Mean power

The average harvested power due to the white-noise base acceleration with a circuit with an inductor can be obtained as

$$E[\tilde{P}] = \frac{m\alpha\beta\kappa^2\pi(\beta + 2\alpha\zeta)}{\beta(\beta + 2\alpha\zeta)(1 + 2\alpha\zeta)(\alpha\kappa^2 + 2\zeta) + 2\alpha^2\zeta(\beta - 1)^2}.$$

- We can determine optimum values for  $\alpha$  and  $\beta$ . Dividing both the numerator and denominator of the above expression by  $\beta(\beta + 2\alpha\zeta)$  shows that the optimum value of  $\beta$  for all values of the other parameters is  $\beta = 1$ . This value of  $\beta$  implies that  $\omega_n^2 LC_p = 1$ , and thus the mechanical and electrical natural frequencies are equal.
- With  $\beta = 1$  the average normalized harvested power is

$$E[\tilde{P}] = \frac{m\alpha\kappa^2\pi}{(1 + 2\alpha\zeta)(\alpha\kappa^2 + 2\zeta)}. \quad (29)$$

If  $\kappa$  and  $\zeta$  are fixed then the maximum power with respect to  $\alpha$  is obtained when  $\alpha = 1/\kappa$ .

## Normalised mean power: numerical illustration

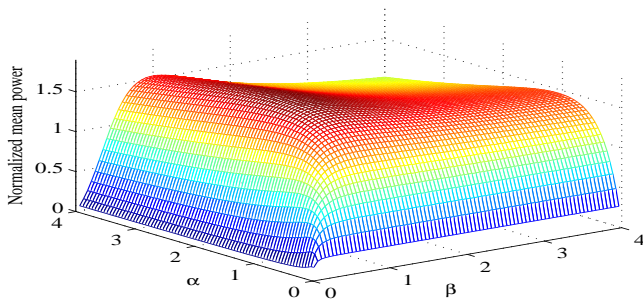

The normalized mean power of a harvester with an inductor as a function of  $\alpha$  and  $\beta$ , with  $\zeta = 0.1$  and  $\kappa = 0.6$ .



## Optimal parameter selection

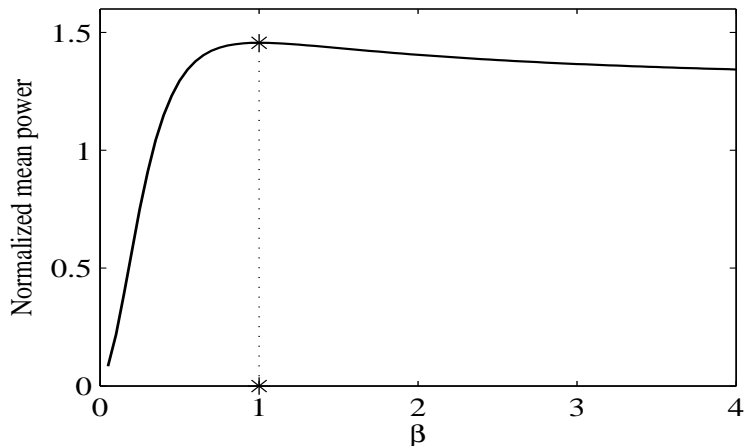

The normalized mean power of a harvester with an inductor as a function of  $\beta$  for  $\alpha = 0.6$ ,  $\zeta = 0.1$  and  $\kappa = 0.6$ . The \* corresponds to the optimal value of  $\beta (= 1)$  for the maximum mean harvested power.

## Optimal parameter selection

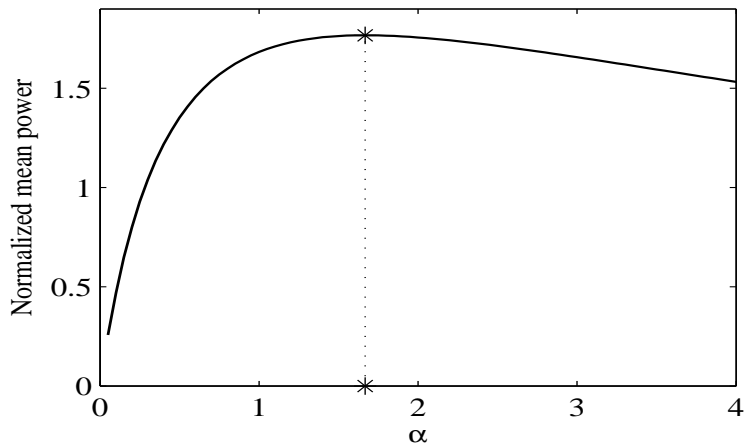

The normalized mean power of a harvester with an inductor as a function of  $\alpha$  for  $\beta = 1$ ,  $\zeta = 0.1$  and  $\kappa = 0.6$ . The \* corresponds to the optimal value of  $\alpha (= 1.667)$  for the maximum mean harvested power.

## Stochastic system parameters

- Energy harvesting devices are expected to be produced in bulk quantities
- It is expected to have some parametric variability across the 'samples'
- How can we take this into account and optimally design the parameters?

The natural frequency of the harvester,  $\omega_n$ , and the damping factor,  $\zeta_n$ , are assumed to be random in nature and are defined as

$$\omega_n = \bar{\omega}_n \Psi_\omega \quad (30)$$

$$\zeta = \bar{\zeta} \Psi_\zeta \quad (31)$$

where  $\Psi_\omega$  and  $\Psi_\zeta$  are the random parts of the natural frequency and damping coefficient.  $\bar{\omega}_n$  and  $\bar{\zeta}$  are the mean values of the natural frequency and damping coefficient.

## Mean harvested power: Harmonic excitation

The average (mean) normalized power can be obtained as

$$\begin{aligned} E[P] &= E\left[\frac{|V|^2}{(R_l \omega^4 X_b^2)}\right] \\ &= \frac{\bar{k} \alpha \kappa^2 \Omega^2}{\bar{\omega}_n^3} \int_{-\infty}^{\infty} \int_{-\infty}^{\infty} \frac{f_{\psi_\omega}(x_1) f_{\psi_\zeta}(x_2)}{\Delta_1(i\Omega, x_1, x_2) \Delta_1^*(i\Omega, x_1, x_2)} dx_1 dx_2 \quad (32) \end{aligned}$$

where

$$\begin{aligned} \Delta_1(i\Omega, \psi_\omega, \psi_\zeta) &= (i\Omega)^3 \alpha + (2\bar{\zeta} \alpha \psi_\omega \psi_\zeta + 1) (i\Omega)^2 + \\ &\quad (\alpha \psi_\omega^2 + \kappa^2 \alpha + 2\bar{\zeta} \psi_\omega \psi_\zeta) (i\Omega) + \psi_\omega^2 \quad (33) \end{aligned}$$

The probability density functions (pdf) of  $\psi_\omega$  and  $\psi_\zeta$  are denoted by  $f_{\psi_\omega}(x)$  and  $f_{\psi_\zeta}(x)$  respectively.

# The mean power

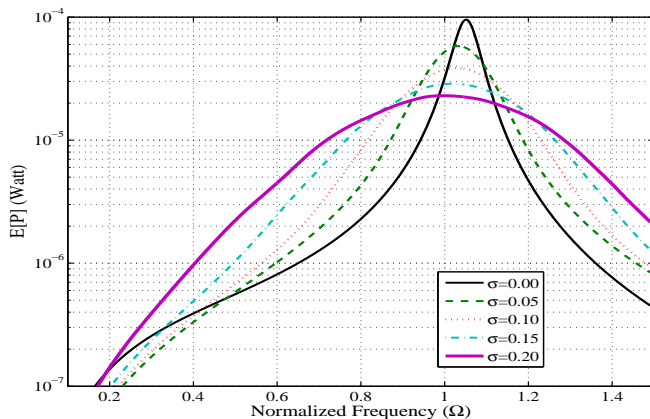

The mean power for various values of standard deviation in natural frequency with  $\bar{\omega}_n = 670.5$  rad/s,  $\Psi_\zeta = 1$ ,  $\alpha = 0.8649$ ,  $\kappa^2 = 0.1185$ .

# The mean power

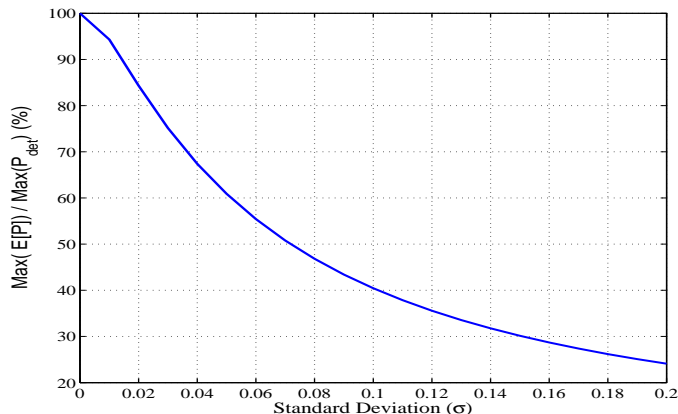

The mean harvested power for various values of standard deviation of the natural frequency, normalised by the deterministic power ( $\bar{\omega}_n = 670.5 \text{ rad/s}$ ,  $\Psi_\zeta = 1$ ,  $\alpha = 0.8649$ ,  $\kappa^2 = 0.1185$ ).

## Optimal parameter selection

The optimal value of  $\alpha$ :

$$\alpha_{\text{opt}}^2 \approx \frac{(c_1 + c_2\sigma^2 + 3c_3\sigma^4)}{(c_4 + c_5\sigma^2 + 3c_6\sigma^4)} \quad (34)$$

where

$$c_1 = 1 + (4\bar{\zeta}^2 - 2)\Omega^2 + \Omega^4, \quad c_2 = 6 + (4\bar{\zeta}^2 - 2)\Omega^2, \quad c_3 = 1, \quad (35)$$

$$c_4 = (1 + 2\kappa^2 + \kappa^4)\Omega^2 + (4\bar{\zeta}^2 - 2 - 2\kappa^2)\Omega^4 + \Omega^6, \quad (36)$$

$$c_5 = (2\kappa^2 + 6)\Omega^2 + (4\bar{\zeta}^2 - 2)\Omega^4, \quad c_6 = \Omega^2, \quad (37)$$

and  $\sigma$  is the standard deviation in natural frequency.

## Optimal parameter selection

The optimal value of  $\kappa$ :

$$\kappa_{\text{opt}}^2 \approx \frac{1}{(\alpha \Omega)} \sqrt{(d_1 + d_2 \sigma^2 + d_3 \sigma^4)} \quad (38)$$

where

$$d_1 = 1 + (4\bar{\zeta}^2 + \alpha^2 - 2) \Omega^2 + (4\bar{\zeta}^2 \alpha^2 - 2\alpha^2 + 1) \Omega^4 + \alpha^2 \Omega^6 \quad (39)$$

$$d_2 = 6 + (4\bar{\zeta}^2 + 6\alpha^2 - 2) \Omega^2 + (4\bar{\zeta}^2 \alpha^2 - 2\alpha^2) \Omega^4 \quad (40)$$

$$d_3 = 3 + 3\alpha^2 \Omega^2 \quad (41)$$



## Nonlinear coupled equations

$$\ddot{x} + 2\zeta\dot{x} + g(x) - \chi v = f(t) \quad (42)$$

$$\dot{v} + \lambda v + \kappa\dot{x} = 0, \quad (43)$$

The nonlinear stiffness is represented as  $g(x) = -\frac{1}{2}(x - x^3)$ . Assuming a non-zero mean random excitation (i.e.,  $f(t) = f_0(t) + m_f$ ) and a non-zero mean system response (i.e.,  $x(t) = x_0(t) + m_x$ ), the following equivalent linear system is considered,

$$\ddot{x}_0 + 2\zeta\dot{x}_0 + a_0x_0 + b_0 - \chi v = f_0(t) + m_f \quad (44)$$

where  $f_0(t)$  and  $x_0(t)$  are zero mean random processes.  $m_f$  and  $m_x$  are the mean of the original processes  $f(t)$  and  $x(t)$  respectively.  $a_0$  and  $b_0$  are the constants to be determined with  $b_0 = m_f$  and  $a_0$  represents the square of the natural frequency of the linearized system  $\omega_{eq}^2$ .

## Linearised equations

We minimise the expectation of the error norm i.e.,  $(\mathbb{E} [\epsilon^2])$ , with  $\epsilon = g(x) - a_0 x_0 - b_0$ . To determine the constants  $a_0$  and  $b_0$  in terms of the statistics of the response  $x$ , we take partial derivatives of the error norm *w.r.t.*  $a_0$  and  $b_0$  and equate them to zero individually.

$$\frac{\partial}{\partial a_0} \mathbb{E} [\epsilon^2] = \mathbb{E} [g(x)x_0] - a_0 \mathbb{E} [x_0^2] - b_0 \mathbb{E} [x_0] \quad (45)$$

$$\frac{\partial}{\partial b_0} \mathbb{E} [\epsilon^2] = \mathbb{E} [g(x)] - a_0 \mathbb{E} [x_0] - b_0 \quad (46)$$

Equating (45) and (46) to zero, we get,

$$a_0 = \frac{\mathbb{E} [g(x)x_0]}{\mathbb{E} [x_0^2]} = \frac{\mathbb{E} [g(x)x_0]}{\sigma_x^2} \quad (47)$$

$$b_0 = \mathbb{E} [g(x)] = m_f \quad (48)$$

# Responses of the piezomagnetoelastic oscillator

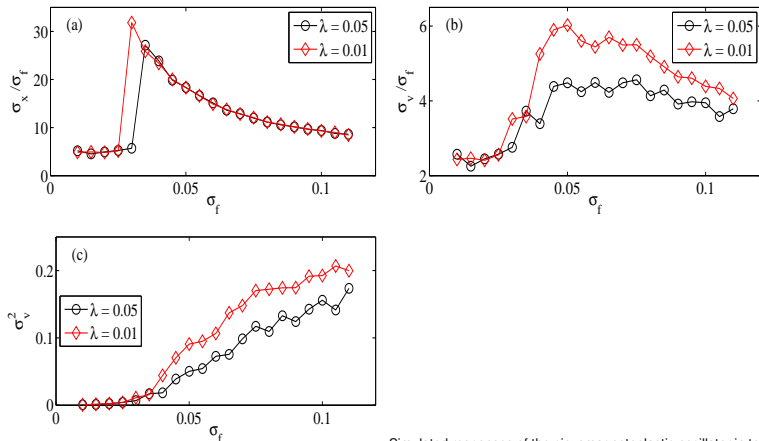

Simulated responses of the piezomagnetoelastic oscillator in terms of the standard

deviations of displacement and voltage ( $\sigma_x$  and  $\sigma_v$ ) as the standard deviation of the random excitation  $\sigma_f$  varies. (a) gives the ratio of the displacement and excitation; (b) gives the ratio of the voltage and excitation; and (c) shows the variance of the voltage, which is proportional to the mean power.

# Phase portraits

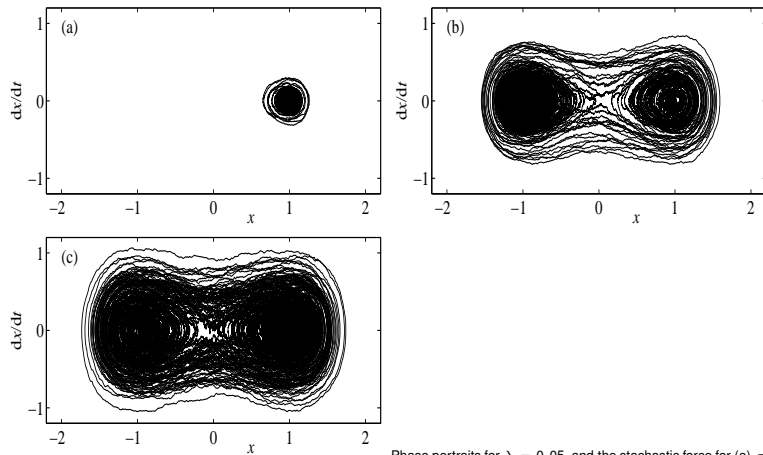

Phase portraits for  $\lambda = 0.05$ , and the stochastic force for (a)  $\sigma_f = 0.025$ , (b)

$\sigma_f = 0.045$ , (c)  $\sigma_f = 0.065$ . Note that the increasing noise level overcomes the potential barrier resulting in a significant increase in the displacement  $x$ .

## Voltage output

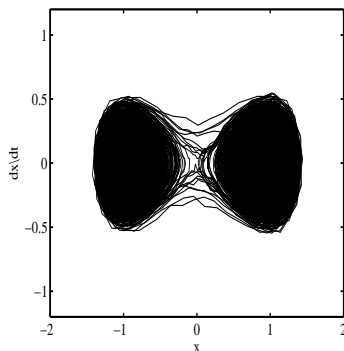
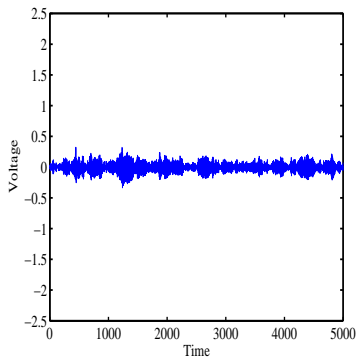

Voltage output due to Gaussian white noise ( $\zeta = 0.01$ ,  $\chi = 0.05$ , and  $\kappa = 0.5$  and  $\lambda = 0.01$ ).

## Voltage output

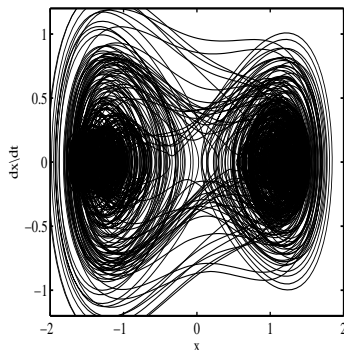
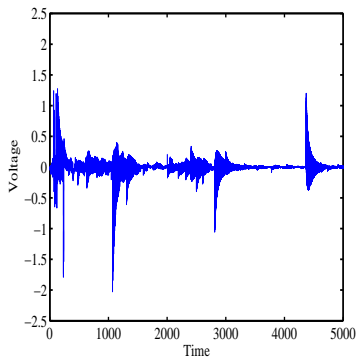

Voltage output due to Lévy noise ( $\zeta = 0.01$ ,  $\chi = 0.05$ , and  $\kappa = 0.5$  and  $\lambda = 0.01$ ).

# Inverted beam harvester

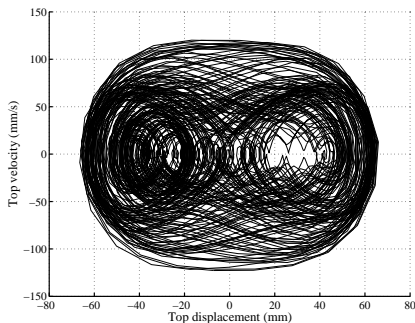
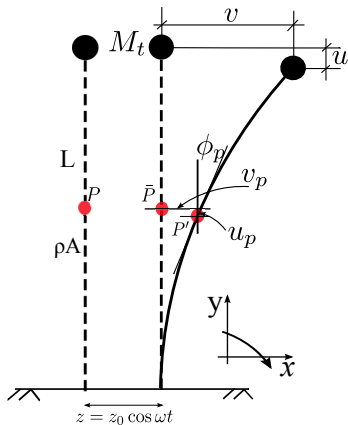

(a) Schematic diagram of inverted beam harvester, (b) a typical phase portrait of the tip mass.

## Fokker-Planck (FP) equation analysis for nonlinear EH

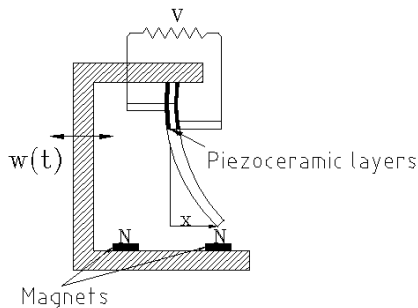

$$\ddot{X} + c\dot{X} + k(-X + \alpha X^3) - \chi V = \sigma W(t), \quad (49)$$

$$\dot{V} + \lambda V + \beta \dot{X} = 0 \quad (50)$$

$W(t)$  is a stationary, zero mean unit Gaussian white noise process with  $E[W(t)W(t+\tau)] = \delta(\tau)$ ,  $\sigma$  is the intensity of excitation. The two sided power spectral density of the white noise excitation on the RHS of Eq. (49) corresponding to this intensity is  $\sigma^2/2\pi$ .



## State-space form

- Eqs. (49) and (50) can be expressed in state space form by introducing the variables  $X_1 = X$ ,  $X_2 = \dot{X}$  and  $X_3 = V$ , as

$$\begin{pmatrix} dX_1(t) \\ dX_2(t) \\ dX_3(t) \end{pmatrix} = \begin{pmatrix} X_2 \\ k(X_1 - \alpha X_1^3) - cX_2 + \chi X_3 \\ -\beta X_2 - \lambda X_3 \end{pmatrix} dt + \begin{pmatrix} 0 \\ \sigma \\ 0 \end{pmatrix} dB(t). \quad (51)$$

where  $B(t)$  is the unit Wiener process.

- The FP equation can be derived from the Itô SDE of the form

$$d\mathbf{X}(t) = \mathbf{m}[\mathbf{X}, t]dt + \mathbf{h}[\mathbf{X}, t]dB, \quad (52)$$

where  $B(t)$  is the normalized Wiener process and the corresponding FP equation of  $\mathbf{X}(t)$  is given by

$$\frac{\partial p(\mathbf{X}, t | \mathbf{X}^0, t_0)}{\partial t} = \left[ - \sum_{i=1}^N \frac{\partial [m_i(\mathbf{X}, t)]}{\partial X_i} + \frac{1}{2} \sum_{i=1}^N \sum_{j=1}^N \frac{\partial^2 [h_{ij}(\mathbf{X}, t)]}{\partial X_i \partial X_j} \right] p(\mathbf{X}, t | \mathbf{X}^0, t_0) \quad (53)$$

where  $p(\mathbf{X}, t)$  is the joint PDF of the  $N$ -dimensional system state  $\mathbf{X}$

## FP equation for nonlinear stochastic EH problems

- Eqs. (51) of the energy harvesting system are of the form of the SDE (52) and the corresponding FP equation can be expressed as per Eq. (53) as

$$\begin{aligned} \frac{\partial p}{\partial t} = & -X_2 \frac{\partial p}{\partial X_1} + (cX_2 - k(X_1 + \alpha X_1^3) - \chi X_3) \frac{\partial p}{\partial X_2} + \\ & (\beta X_2 + \lambda X_3) \frac{\partial p}{\partial X_3} + \frac{\sigma^2}{2} \frac{\partial^2 p}{\partial X_2^2} + (c + \lambda)p \end{aligned} \quad (54)$$

where  $p = p(\mathbf{X}, t | \mathbf{X}^0, t_0)$  the joint transition PDF of the state variables is used for notational convenience satisfying the conditions

$$\int_{-\infty}^{\infty} p(\mathbf{X}, t | \mathbf{X}^0, t_0) d\mathbf{X} = 1, \quad \lim_{t \rightarrow 0} p(\mathbf{X}, t | \mathbf{X}^0, t_0) = \delta(\mathbf{X} - \mathbf{X}^0), \quad (55)$$

$$p(\mathbf{X}, t | \mathbf{X}^0, t_0) |_{X_i \rightarrow \pm\infty} = 0, \quad (i = 1, \dots, n). \quad (56)$$

- A finite element (FE) based method is developed for the solution of the FP equation.

## FEM for FP equations

- The weak form of the FP equation can be obtained as

$$\mathbf{M}\dot{\mathbf{p}} + \mathbf{K}\mathbf{p} = \mathbf{0}, \quad (57)$$

subject to the initial condition  $\mathbf{p}(0) = \mathbf{p}$ , where,  $\mathbf{p}$  is a vector of the joint PDF at the nodal points.

$$\mathbf{M} = [\langle \psi_r, \psi_s \rangle]_{\Omega}, \quad (58)$$

$$\mathbf{K} = \int_{\Omega} \left[ \sum_{i=1}^N \psi_r(\mathbf{X}) \frac{\partial [m_i(\mathbf{X}) \psi_s(\mathbf{X})]}{\partial X_j} \right] d\mathbf{X} + \int_{\Omega} \left[ \sum_{i=1}^N \sum_{j=1}^N \frac{\partial [\psi_r(\mathbf{X})]}{\partial X_i} \frac{\partial [h_{ij} \psi_s(\mathbf{X})]}{\partial X_j} \right] d\mathbf{X}. \quad (59)$$

- A solution of Eq. (57) is obtained using the Crank-Nicholson method, which is an implicit time integration scheme with second order accuracy and unconditional stability:

$$[\mathbf{M} - \Delta t(1 - \theta)\mathbf{K}]\mathbf{p}(t + \Delta t) = [\mathbf{M} + \Delta t\theta\mathbf{K}]\mathbf{p}(t). \quad (60)$$

The parameter  $\theta = 0.5$  and  $\Delta t$  is the time step.

## Joint PDF of the response

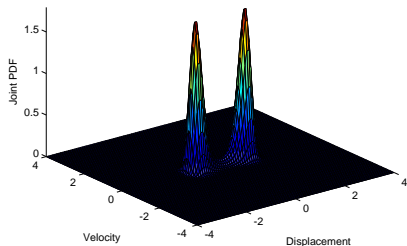

(a) Response PDF

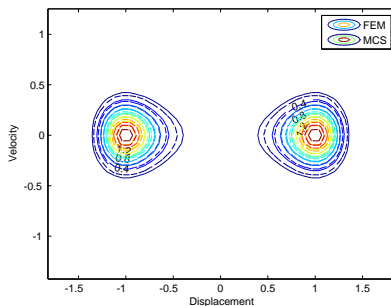

(b) Contour plot comparison

**Figure:** Joint PDF and contour plots of piezomagnetoelastic Energy Harvester  
( $c = 0.02$ ,  $\lambda = 0.01$ ,  $\sigma = 0.04$ )

# Joint PDF of the response

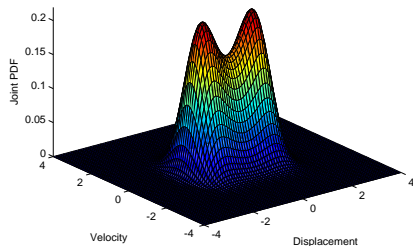

(a) Response PDF

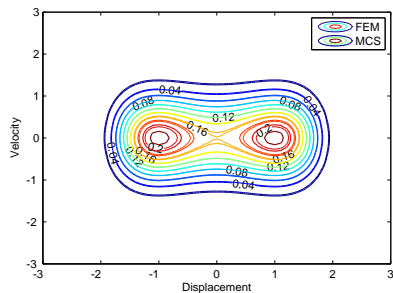

(b) Contour plot comparison

**Figure:** Joint PDF and contour plots of piezomagnetoelastic Energy Harvester  
 ( $c = 0.02, \lambda = 0.01, \sigma = 0.12$ )

# Energy harvesting from bridge vibration

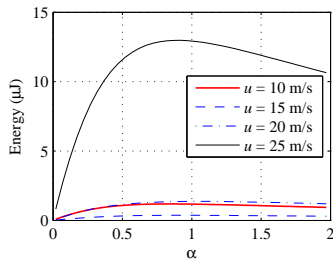
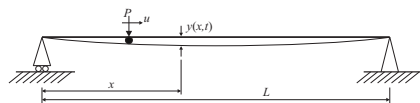

(a) Schematic diagram of a beam with a moving point load, (b) The variation in the energy generated by the harvester located at  $L/3$  with  $\alpha$  for a single vehicle traveling at different speeds,  $u$

## Energy Harvesting Dynamic Vibration Absorber (EHDVA)

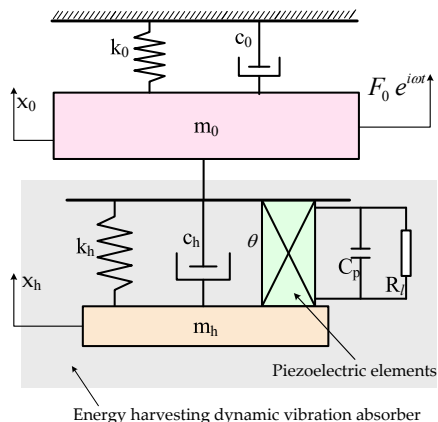

Schematic diagram of energy harvesting dynamic vibration absorber attached to a single degree of freedom vibrating system.

- The aim is to reduce vibration of a primary structure and simultaneously harvest energy from a secondary structure
- The mass, stiffness and the damping of the primary structure are represented as  $m_0$ ,  $k_0$  and  $c_0$  respectively, whereas the energy harvesting DVA has an equivalent mass, equivalent stiffness and damping as  $m_h$ ,  $k_h$  and  $c_h$  respectively.
- The electrical capacitance and resistance are denoted by  $C_p$  and  $R_l$  respectively.
- The variable  $\theta$  is the coupling between the electrical and mechanical parts of the harvester.

## Equation of motion of EHDVA

- The dynamics of the primary mass ( $m_0$ ), the absorber mass ( $m_h$ ) and voltage flow can be expressed by three coupled ordinary differential equations as

$$m_0 \ddot{x}_0 + c_0 \dot{x}_0 + k_0 x_0 - k_h(x_h - x_0) - c_h(\dot{x}_h - \dot{x}_0) = F_0 e^{i\omega t} \quad (61)$$

$$m_h \ddot{x}_h + c_h(\dot{x}_h - \dot{x}_0) + k_h(x_h - x_0) - \theta v = 0 \quad (62)$$

$$C_p \dot{v} + \frac{1}{R_l} + \theta \dot{x}_h = 0 \quad (63)$$

where  $x_0$  and  $x_h$  are the displacement of the primary mass and absorber mass respectively.

- The voltage across the the load resistor is denoted by  $v$ .
- The steady state solution of the Equations (61) - (63) can be written as

$$x_0 = X_0 e^{i\omega t}, \quad x_h = X_h e^{i\omega t} \quad \text{and} \quad v = V e^{i\omega t} \quad (64)$$



## Equation of motion of EHDVA

- Substituting (64) into Equations (61) - (63) and then normalizing with respect to the resonance frequency of the primary mass  $\omega_0 = \sqrt{k_0/m_0}$ , we get

$$[-\Omega^2 + 2(\zeta_0 + \zeta_h \mu \beta) i \Omega + (1 + \mu \beta^2)] X_0 - \mu(2\zeta_h \beta i \Omega + \beta^2) X_h = F_0/k_0 \quad (65)$$

$$-(2\zeta_h \beta i \Omega + \beta^2) X_0 + [-\Omega^2 + 2\zeta_h \beta i \Omega + \beta^2] X_h - \frac{\theta}{k_h} \beta^2 V = 0 \quad (66)$$

$$\frac{\theta \alpha}{C_p} i \Omega X_h + (\beta + \alpha i \Omega) V = 0 \quad (67)$$

- Here  $\mu = m_h/m_0$  is the ratio of the absorber mass to the primary mass, known as mass ratio,  $\beta = \omega_h/\omega_0$  is the ratio of decoupled absorber frequency to the natural frequency of the primary structure, known as frequency ratio,  $\Omega = \omega/\omega_0$  is the nondimensional frequency of excitation, and  $\alpha = \omega_n C_p R_l$  is the dimensionless time constant. The coefficient of damping in the primary structure is given by  $\zeta_0 = c_0/(2m_0\omega_0)$  whereas  $\zeta_h = c_h/(2m_h\omega_h)$  is the damping coefficient of the absorber.

## Dynamic response of EHDVA

- Solving Equations (65) - (67) for the displacement amplitudes  $X_0$  and  $X_h$ , and for the voltage amplitude  $V$ , we get

$$\left| \frac{X_0}{F_0/k_0} \right| = \frac{\left\{ a_{0_0} + a_{0_2} (i\Omega)^2 \right\}^2 + \left\{ a_{0_1} (i\Omega) + a_{0_3} (i\Omega)^3 \right\}^2}{|\Delta|^2} \quad (68)$$

$$\left| \frac{X_h}{F_0/k_0} \right| = - \frac{\left\{ a_{h_0} + a_{h_2} (i\Omega)^2 \right\}^2 + \left\{ a_{h_1} (i\Omega) \right\}^2}{|\Delta|^2} \quad (69)$$

$$\left| \frac{V}{F_0/k_0} \right| = \frac{\left\{ a_{v_0} + a_{v_2} (i\Omega)^2 \right\}^2 + \left\{ a_{v_1} (i\Omega) \right\}^2}{|\Delta|^2} \quad (70)$$

- Equations (68) - (70) are normalized with respect to the static displacement of the primary structure ( $F_0/k_0$ ), to make the expressions on the right hand side independent of the excitation amplitude. The denominator is given as,

$$\Delta = b_0 + b_1 (i\Omega) + b_2 (i\Omega)^2 + b_3 (i\Omega)^3 + b_4 (i\Omega)^4 + b_5 (i\Omega)^5 \quad (71)$$

# Optimal parameters

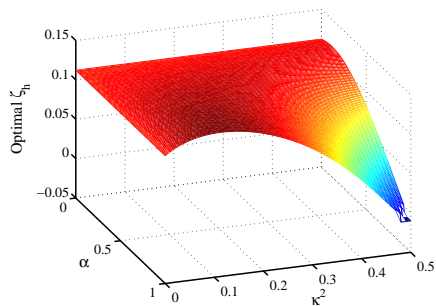
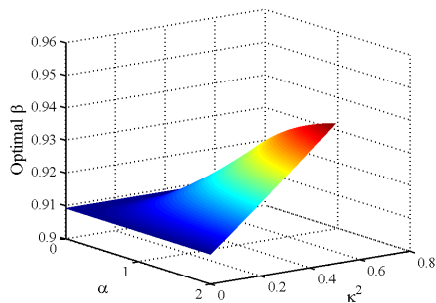

(a) Optimal values of ratio of decoupled natural frequencies ( $\beta$ ) for various values of  $\alpha = \omega_n C_p R_l$  (dimensionless time constant) and  $\kappa^2 = \theta^2 / (k_h C_p)$  (nondimensional electromechanical coupling constant), (b) Optimal damping of the EHDVA ( $\zeta_h$ ) for various values of  $\alpha$  and  $\kappa^2$

## Primary structure response

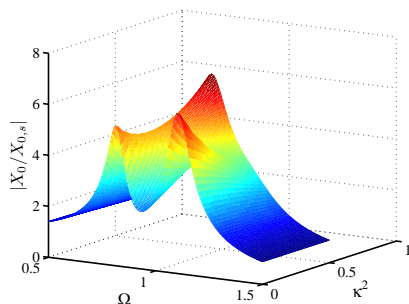
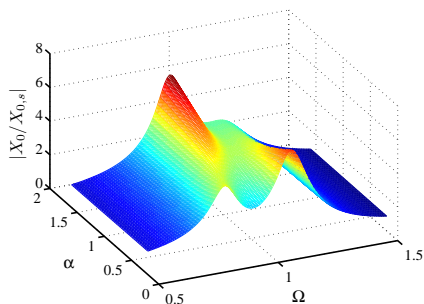

(a) Primary structure response for nondimensional coupling coefficient  $\kappa^2 = 0.3$ , (b) Primary structure response for nondimensional time constant  $\alpha = 1$

# Harvested power

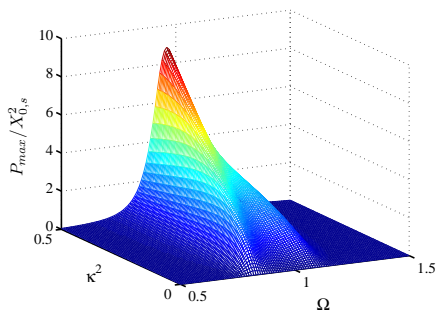
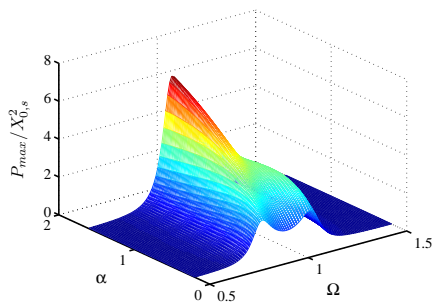

(a) Harvested power in  $mW/m^2$  for nondimensional coupling coefficient  $\kappa^2 = 0.3$ , (b) Harvested power in  $mW/m^2$  for nondimensional time constant  $\alpha = 1$

## Summary and Conclusions

- Vibration energy based piezoelectric and magnetopiezoelectric energy harvesters are expected to operate under a wide range of ambient environments. This talk considers energy harvesting of such systems under harmonic and random excitations.
- Optimal design parameters were obtained using the theory of linear random vibration
- Nonlinearity of the system can be exploited to scavenge more energy over wider operating conditions
- Uncertainty in the system parameters can have dramatic affect on energy harvesting. This should be taken into account for optimal design
- The Fokker-Planck equation corresponding to the nonlinear piezomagneto-elastic energy harvester excited by Gaussian white noise was derived and solved using the finite element method
- It is possible to reduce the vibration of a primary structure and simultaneously harvest energy from the vibration of an attached vibration absorber

## Further details

- 1 [http://engweb.swan.ac.uk/~adhikaris/renewable\\_energy.html](http://engweb.swan.ac.uk/~adhikaris/renewable_energy.html)
- 2 Friswell, M. I., Bilgen, O., Ali, S. F., Litak, G. and Adhikari, S., "The effect of noise on the response of a vertical cantilever beam energy harvester", *Zeitschrift fur Angewandte Mathematik und Mechanik (ZAMM)*.
- 3 Borowiec, B., Litak, G., Friswell, M. I. and Adhikari, S., "Energy harvesting in a nonlinear cantilever piezoelastic beam system excited by random vertical vibrations", *International Journal of Structural Stability and Dynamics*, 14[8] (2014), pp. 1440018:1-13.
- 4 Kumar, P., Narayanan, S., Adhikari, S. and Friswell, M. I., "Fokker-Planck equation analysis of randomly excited nonlinear energy harvester", *Journal of Sound and Vibration*, 333[7] (2014), pp. 2040-2053.
- 5 Borowiec, B., Litak, G., Friswell, M. I., Ali, S. F., Adhikari, S. and Lees, A. W. and Bilgen, O., "Energy harvesting in piezoelastic systems driven by random excitations", *International Journal of Structural Stability and Dynamics*, 13[7] (2013), pp. 1340006:1-11
- 6 Ali, S. F. and Adhikari, S., "Energy harvesting dynamic vibration absorbers", *Transactions of ASME, Journal of Applied Mechanics*.
- 7 Friswell, M. I., Ali, S. F., Adhikari, S., Lees, A.W. , Bilgen, O. and Litak, G., "Nonlinear piezoelectric vibration energy harvesting from an inverted cantilever beam with tip mass", *Journal of Intelligent Material Systems and Structures*, 23[3] (2012), pp. 1505-1521.
- 8 Litak, G., Friswell, M. I., Kitio Kwuimy, C. A., Adhikari, S. and Borowiec, B., "Energy harvesting by two magnetopiezoelectric oscillators with mistuning", *Theoretical & Applied Mechanics Letters*, 2[4] (2012), pp. 043009.
- 9 Ali, S. F., Friswell, M. I. and Adhikari, S., "Analysis of energy harvesters for highway bridges", *Journal of Intelligent Material Systems and Structures*, 22[16] (2011), pp. 1929-1938.

## Further details

- 10 Jacquelin, E., Adhikari, S. and Friswell, M. I., "Piezoelectric device for impact energy harvesting", *Smart Materials and Structures*, 20[10] (2011), pp. 105008:1-12.
- 11 Litak, G., Borowiec, B., Friswell, M. I. and Adhikari, S., "Energy harvesting in a magnetopiezoelectric system driven by random excitations with uniform and Gaussian distributions", *Journal of Theoretical and Applied Mechanics*, 49[3] (2011), pp. 757-764..
- 12 Ali, S. F., Adhikari, S., Friswell, M. I. and Narayanan, S., "The analysis of piezomagnetoelastic energy harvesters under broadband random excitations", *Journal of Applied Physics*, 109[7] (2011), pp. 074904:1-8
- 13 Ali, S. F., Friswell, M. I. and Adhikari, S., "Piezoelectric energy harvesting with parametric uncertainty", *Smart Materials and Structures*, 19[10] (2010), pp. 105010:1-9.
- 14 Friswell, M. I. and Adhikari, S., "Sensor shape design for piezoelectric cantilever beams to harvest vibration energy", *Journal of Applied Physics*, 108[1] (2010), pp. 014901:1-6.
- 15 Litak, G., Friswell, M. I. and Adhikari, S., "Magnetopiezoelectric energy harvesting driven by random excitations", *Applied Physics Letters*, 96[5] (2010), pp. 214103:1-3.
- 16 Adhikari, S., Friswell, M. I. and Inman, D. J., "Piezoelectric energy harvesting from broadband random vibrations", *Smart Materials and Structures*, 18[11] (2009), pp. 115005:1-7.



## Future research directions

- Huge potential for the application of classical/modern random vibration analysis techniques
- Vibration energy harvesting under non-Gaussian random excitations - linear and nonlinear systems
- Generalization of the results of PF equation to higher dimensional cases (3 or 4 dimensional state-space models)
- Stability issues - energy harvesting from instability?
- Vibration control - simultaneous control and energy harvesting - extension of EHDVA - perhaps active control?
- Stochastic systems + nonlinearity in higher dimensions
- Hybrid piezo-electric and electro magnetic energy harvesting
- Multi-space energy harvesting - incorporating nano-scale piezoelectric materials such as ZnO, GaN and BN nano tubes and nano wires
- Parameter optimisation
- Experimental validation