

## Eigenderivative analysis of asymmetric non-conservative systems

Sondipon Adhikari<sup>1</sup> and Michael I. Friswell<sup>2,\*†</sup>

<sup>1</sup>*Department of Engineering, University of Cambridge, Trumpington Street, Cambridge CB2 1PZ, U.K.*

<sup>2</sup>*Department of Mechanical Engineering, University of Wales Swansea, Swansea SA2 8PP, Wales, U.K.*

### SUMMARY

In general, the damping matrix of a dynamic system or structure is such that it can not be simultaneously diagonalized with the mass and stiffness matrices by any linear transformation. For this reason the eigenvalues and eigenvectors and consequently their derivatives become complex. Expressions for the first- and second-order derivatives of the eigenvalues and eigenvectors of these linear, non-conservative systems are given. Traditional restrictions of symmetry and positive definiteness have not been imposed on the mass, damping and stiffness matrices. The results are derived in terms of the eigenvalues and left and right eigenvectors of the second-order system so that the undesirable use of the first-order representation of the equations of motion can be avoided. The usefulness of the derived expressions is demonstrated by considering a non-proportionally damped two degree-of-freedom symmetric system, and a damped rigid rotor on flexible supports. Copyright © 2001 John Wiley & Sons, Ltd.

KEY WORDS: asymmetric systems; complex modes; sensitivity analysis; nonconservative systems

### 1. INTRODUCTION

The characterization of eigenvalues and eigenvectors constitutes a central role in the design, analysis and identification of linear dynamic systems. As a result, the study of the variation of the eigenvalues and eigenvectors due to variations in the system parameters, or more precisely the sensitivity of eigensolutions, has emerged as an important area of research. Sensitivity of eigenvalues and eigenvectors with respect to some system parameters may be represented by their derivatives with respect to those parameters. In one of the earliest works, Fox and Kapoor [1] gave exact expressions for the first derivative of eigenvalues and eigenvectors with respect to any design variable. Their results were obtained in terms of changes in the system property matrices and the eigensolutions of the structure, and have been used extensively in a

---

\*Correspondence to: Michael Friswell, Department of Mechanical Engineering, University of Wales Swansea, Swansea SA2 8PP, Wales, U.K.

†E-mail: m.i.friswell@swansea.ac.uk

Contract/grant sponsor: Nehru Memorial Trust

Contract/grant sponsor: EPSRC Advanced Fellowship Award

wide range of application areas of structural dynamics. The expressions derived in Reference [1] are valid for symmetric undamped systems.

However, it is well known that in many problems in dynamics the inertia, stiffness and damping properties of the system cannot be represented by symmetric matrices or self-adjoint differential operators. These kinds of problems typically arise in the dynamics of actively controlled structures and in many general non-conservative dynamic systems, for example—moving vehicles on roads, missile following trajectories, ship motion in sea water or the study of aircraft flutter. The asymmetry of damping and stiffness terms is often addressed in the context of gyroscopic and follower forces. Many authors [2–5] have extended Fox and Kapoor's [1] approach to determine eigensolution derivatives for more general asymmetric *conservative* systems. For these kinds of systems, Nelson [6] proposed an efficient method to calculate the first-order derivative of eigenvectors which requires only the eigenvalue and eigenvector under consideration. Murthy and Haftka [7] have written an excellent review on calculating the derivatives of eigenvalues and eigenvectors associated with general (non-Hermitian) matrices.

The work discussed so far does not explicitly consider the damping present in the system. In order to apply these results to systems with general non-proportional damping it is required to convert the equations of motion into state-space form (see Reference [8] for example). Although exact in nature, the state-space methods require significant numerical effort as the size of the problem doubles. Moreover, these methods also lack some of the intuitive simplicity of the analysis based on '*N*-space'. For these reasons the determination of the derivatives of eigenvalues and eigenvectors in *N*-space for non-conservative systems is very desirable. Note that unlike undamped systems, in damped systems the eigenvalues and eigenvectors, and consequently their derivatives, become complex in general. Recently, some authors have considered the problem of the calculation of first-order derivatives of eigensolutions of viscously damped symmetric systems. Bhaskar [9] has obtained the derivative of eigenvalues using a first-order formalism. Lee *et al.* [10, 11] have proposed a similar approach to determine natural frequency and mode shape sensitivities of damped systems. Recently, Adhikari [12] derived an exact expression for the first-order derivative of complex eigenvalues and eigenvectors. The results were expressed in terms of the complex eigenvalues and eigenvectors of the second-order system and the first-order representation of the equation of motion was avoided. Later Adhikari [13] suggested an approximate method to calculate the first derivative of complex modes using a modal series involving only classical normal modes.

First-order derivatives are useful for practical problems as long as the perturbations of the system parameters remain 'small'. To consider a wide range of changes in the design parameters the linear approximation associated with the first-order derivatives may not be sufficient. Apart from large perturbations of system parameters, Brandon [14] has shown that the second-order eigensolution derivatives are not negligible compared to the first-order derivatives when the system has closely spaced natural frequencies. Second-order eigensolution derivatives are also required in design optimization to calculate the so-called 'Hessian Matrix'. For these reasons there has been considerable interest in obtaining the second-order derivatives of the eigensolutions. Plaut and Huseyin [3] gave an expression for the second derivative of the eigenvalues for asymmetric systems. Rudisill [5] suggested a similar expression for the second derivative of the eigenvalues and went on to derive the second derivative of the eigenvectors. Brandon [15] derived the second derivative of the eigenvalues and eigenvectors for the case when the system matrices are linear functions of the design variables.

Chen *et al.* [16, 17] derived the second-order derivative of eigenvectors in terms of a series in the eigenvectors. Friswell [18] proposed a method, similar to Reference [6], to obtain the second-order derivative of the eigenvectors which employs only the eigensolutions of interest. Most of the methods discussed so far do not explicitly consider damped systems. In order to apply these results to obtain the second derivatives of the eigensolutions of general (non-proportionally) damped systems, the state-space formalism is required.

In this paper, the first and second derivatives of the eigenvalues and eigenvectors of linear asymmetric non-conservative systems are derived in  $N$ -space. It is assumed that, in general, the damping matrix cannot be diagonalized simultaneously with the mass and stiffness matrix by any linear transformation and that the system does not possess repeated eigenvalues. In Section 2, we briefly discuss complex eigenvalues and eigenvectors of asymmetric linear multi-degree-of-freedom discrete systems. The first-order derivatives of the complex eigenvalues are derived in Section 3. The result is expressed in terms of the corresponding right and left eigenvectors and the eigenvalue of the system. In Section 4 the first-order derivative of the right and left eigenvectors are obtained. The derivation uses the first-order representation of equations of motion and then relates the first-order eigenvector derivatives to the right and left eigenvectors of the original system. Joint second-order derivatives of the complex eigenvalues with respect to two design parameters are derived in Section 5 in terms of the first-order derivatives of eigenvalues and eigenvectors obtained before. In Section 6, second order derivatives of right and left eigenvectors are obtained. A symmetric two-degree-of-freedom non-conservative system is considered in Section 7 to illustrate the usefulness of a special case of the derived expressions. A rigid rotor on flexible supports, subject to gyroscopic effects, is used as an example of an asymmetric system.

It should be highlighted that only systems with distinct eigenvalues are considered in this paper. The eigensystem derivatives of conservative systems with repeated eigenvalues have been considered in depth [19–22]. Even for conservative systems, the derivatives with respect to more than one parameter do not exist, in general. The physical reason for this is that small perturbations to the parameters often cause the eigenvalues to become distinct. Unfortunately, these distinct eigenvectors are usually not consistent for different parameters, leading to the notion that only certain sets of parameters are permissible [21, 22]. There is a further difficulty for damped systems. It has recently been shown that if a unit rank change in the viscous damping matrix of a proportional damped system leads to a repeated eigenvalue (that was not an eigenvalue of the original system), then the modified system will be defective [23]. A defective system does not have a full set of eigenvectors, and thus calculating the eigenvalue and eigenvector derivatives for such a system is clearly unreasonable. Recent research has demonstrated that higher rank modifications to the damping matrix also produce defective systems [24]. Because of these difficulties it will be assumed, in this paper, that the eigenvalues are distinct.

## 2. COMPLEX EIGENVALUES AND EIGENVECTORS

The equations of motion describing the free vibration of a linear, damped discrete system with  $N$  degrees-of-freedom are

$$\mathbf{M}\ddot{\mathbf{u}}(t) + \mathbf{C}\dot{\mathbf{u}}(t) + \mathbf{K}\mathbf{u}(t) = \mathbf{0} \quad (1)$$

where  $\mathbf{M}$ ,  $\mathbf{C}$  and  $\mathbf{K} \in \mathbb{R}^{N \times N}$  are the mass, damping and stiffness matrices, respectively,  $\mathbf{u}(t) \in \mathbb{R}^N$  is the vector of generalized co-ordinates, and  $t \in \mathbb{R}^+$  denotes time. The traditional restrictions of symmetry and positive definiteness are not imposed on  $\mathbf{M}$ ,  $\mathbf{C}$  and  $\mathbf{K}$ , however, it is assumed that  $\mathbf{M}^{-1}$  exists. Taking the Laplace transform of Equation (1) and without loss of generality, assuming all the initial conditions are zero, we have

$$s^2 \mathbf{M} \bar{\mathbf{u}} + s \mathbf{C} \bar{\mathbf{u}} + \mathbf{K} \bar{\mathbf{u}} = \mathbf{0} \quad (2)$$

Here,  $\bar{\mathbf{u}}$  is the Laplace transform of  $\mathbf{u}(t)$ ,  $s = i\omega$  with  $i = \sqrt{-1}$  and  $\omega \in \mathbb{R}^+$  denotes frequency. The eigenvalues  $s_j$  associated with Equation (2) are the roots of the characteristic polynomial

$$\det[s^2 \mathbf{M} + s \mathbf{C} + \mathbf{K}] = 0 \quad (3)$$

The order of the polynomial is  $2N$  and the roots appear in complex conjugate pairs. For convenience in this paper, we arrange the eigenvalues as

$$s_1, s_2, \dots, s_N, s_1^*, s_2^*, \dots, s_N^* \quad (4)$$

where  $(\bullet)^*$  denotes complex conjugation. The *right* eigenvalue problem associated with the above equation can be represented by the  $\lambda$ -matrix problem [25]

$$s_j^2 \mathbf{M} \mathbf{u}_j + s_j \mathbf{C} \mathbf{u}_j + \mathbf{K} \mathbf{u}_j = \mathbf{0}, \quad \forall j = 1, \dots, N \quad (5)$$

where  $s_j \in \mathbb{C}$  is the  $j$ th latent root (eigenvalue) and  $\mathbf{u}_j \in \mathbb{C}^N$  is the  $j$ th right latent vector (right eigenvector). The *left* eigenvalue problem can be represented by

$$s_j^2 \mathbf{v}_j^T \mathbf{M} + s_j \mathbf{v}_j^T \mathbf{C} + \mathbf{v}_j^T \mathbf{K} = \mathbf{0}^T, \quad \forall j = 1, \dots, N \quad (6)$$

where  $\mathbf{v}_j \in \mathbb{C}^N$  is the  $j$ th left latent vector (left eigenvector) and  $(\bullet)^T$  denotes the matrix transpose. When  $\mathbf{M}$ ,  $\mathbf{C}$  and  $\mathbf{K}$  are general asymmetric matrices the right and left eigenvectors can easily be obtained from the first-order formulations, for example, the state-space method [26] or Duncan forms [27]. Equation (1) is transformed into the first-order (Duncan) form as

$$\mathcal{A} \dot{\mathbf{z}}(t) + \mathcal{B} \mathbf{z}(t) = \mathbf{0} \quad (7)$$

where  $\mathcal{A}, \mathcal{B} \in \mathbb{R}^{2N \times 2N}$  are the system matrices and  $\mathbf{z}(t) \in \mathbb{R}^{2N}$  is the state vector given by

$$\mathcal{A} = \begin{bmatrix} \mathbf{C} & \mathbf{M} \\ \mathbf{M} & \mathbf{O} \end{bmatrix}, \quad \mathcal{B} = \begin{bmatrix} \mathbf{K} & \mathbf{O} \\ \mathbf{O} & -\mathbf{M} \end{bmatrix} \quad \text{and} \quad \mathbf{z}(t) = \begin{Bmatrix} \mathbf{u}(t) \\ \dot{\mathbf{u}}(t) \end{Bmatrix} \quad (8)$$

In the above equation  $\mathbf{O}$  is the  $N \times N$  null matrix and  $\mathbf{I}_N$  is the  $N \times N$  identity matrix. Taking the Laplace transform of Equation (7) we obtain

$$s \mathcal{A} \bar{\mathbf{z}} + \mathcal{B} \bar{\mathbf{z}} = \mathbf{0} \quad (9)$$

Here,  $\bar{\mathbf{z}}$  is the Laplace transform of  $\mathbf{z}(t)$ . The *right* eigenvalue problem associated with Equation (9) can be expressed as

$$s_j \mathcal{A} \mathbf{z}_j + \mathcal{B} \mathbf{z}_j = \mathbf{0}, \quad \forall j = 1, \dots, 2N \quad (10)$$

where  $s_j \in \mathbb{C}$  is the  $j$ th eigenvalue and  $\mathbf{z}_j \in \mathbb{C}^{2N}$  is the  $j$ th right eigenvector which is related to the  $j$ th right eigenvector of the second-order system as

$$\mathbf{z}_j = \begin{Bmatrix} \mathbf{u}_j \\ s_j \mathbf{u}_j \end{Bmatrix} \quad (11)$$

The *left* eigenvector  $\mathbf{y}_j \in \mathbb{C}^{2N}$  associated with  $s_j$  is defined by

$$s_j \mathbf{y}_j^T \mathcal{A} + \mathbf{y}_j^T \mathcal{B} = \mathbf{0} \tag{12}$$

Assume that the left eigenvectors  $\mathbf{y}_j$  can be expressed by

$$\mathbf{y}_j = \begin{Bmatrix} \mathbf{y}_{1j} \\ \mathbf{y}_{2j} \end{Bmatrix} \tag{13}$$

where  $\mathbf{y}_{1j}, \mathbf{y}_{2j} \in \mathbb{C}^N$ . Substituting  $\mathbf{y}_j$  into Equation (12) and simplifying, the following equations may be obtained:

$$\begin{aligned} s_j (\mathbf{y}_{1j}^T \mathbf{C} + \mathbf{y}_{2j}^T \mathbf{M}) + \mathbf{y}_{1j}^T \mathbf{K} &= 0 \\ s_j \mathbf{y}_{1j}^T \mathbf{M} &= \mathbf{y}_{2j}^T \mathbf{M} \end{aligned} \tag{14}$$

Elimination of  $\mathbf{y}_{2j}$  gives

$$\mathbf{y}_{1j}^T [s_j^2 \mathbf{M} + s_j \mathbf{C} + \mathbf{K}] = 0 \tag{15}$$

By comparing this with Equation (6), one obtains  $\mathbf{y}_{1j} = \mathbf{v}_j$ . Since it has been assumed that  $\mathbf{M}$  is non-singular, from the second equation of (14),  $\mathbf{y}_{2j} = s_j \mathbf{v}_j$ . Thus, the left eigenvectors of the first-order system can be related to those of the second-order system by

$$\mathbf{y}_j = \begin{Bmatrix} \mathbf{v}_j \\ s_j \mathbf{v}_j \end{Bmatrix} \tag{16}$$

For distinct eigenvalues it is easy to show that the right and left eigenvectors satisfy an orthogonality relationship, that is

$$\mathbf{y}_j^T \mathcal{A} \mathbf{z}_k = 0 \quad \text{and} \quad \mathbf{y}_j^T \mathcal{B} \mathbf{z}_k = 0, \quad \forall j \neq k \tag{17}$$

The above two equations imply that the dynamic system defined by (7) possesses set of *biorthogonal* eigenvectors with respect to the system matrices. Premultiplying Equation (10) by  $\mathbf{y}_j^T$  one obtains

$$\mathbf{y}_j^T \mathcal{B} \mathbf{z}_j = -s_j \mathbf{y}_j^T \mathcal{A} \mathbf{z}_j \tag{18}$$

The eigenvectors may be normalized so that

$$\mathbf{y}_j^T \mathcal{A} \mathbf{z}_j = \frac{1}{\gamma_j} \tag{19}$$

where  $\gamma_j \in \mathbb{C}$  is the normalization constant. In view of the expressions of  $\mathbf{z}_j$  and  $\mathbf{y}_j$  in Equations (11) and (16) the above relationship can be expressed in terms of the eigensolutions of the second-order system as

$$\mathbf{v}_j^T [2s_j \mathbf{M} + \mathbf{C}] \mathbf{u}_j = \frac{1}{\gamma_j} \tag{20}$$

There are several ways in which the normalization constants can be selected. The one that is most consistent with traditional modal analysis practice, is to choose  $\gamma_j = 1/2s_j$ . Observe that

this degenerates to the familiar mass normalization relationship  $\mathbf{v}_j^T \mathbf{M} \mathbf{u}_j = 1$  when the damping is zero. It should be noted that  $\gamma_j$  will be assumed constant and should not vary with the design parameters. If  $\gamma_j = 1/2s_j$  then  $\gamma_j$  should be fixed, based on the baseline model.

The normalization in Equation (20) is insufficient and the eigenvectors are not unique to the extent of an unknown scalar multiplier. Normalizing  $\mathbf{u}_j$  and  $\mathbf{v}_j$  so that their norms are equal is insufficient since the eigenvectors may be multiplied by any complex scalar of unit modulus. The normalization approach adopted here was described by Nelson [6] and Murthy and Haftka [7]. For the  $j$ th eigenvector pair the eigenvectors are normalized so that the  $n_j$ th elements are equal. Thus,

$$\{\mathbf{u}_j\}_{n_j} = \{\mathbf{v}_j\}_{n_j} \quad (21)$$

where  $\{\bullet\}_j$  denotes the  $j$ th element of a vector.  $n_j$  is chosen so that the corresponding elements of the eigenvectors are as large as possible. Thus,

$$|\{\mathbf{u}_j\}_{n_j}| |\{\mathbf{v}_j\}_{n_j}| = \max_n |\{\mathbf{u}_j\}_n| |\{\mathbf{v}_j\}_n| \quad (22)$$

The first-order formulation described above, although exact in nature, requires significant numerical effort to obtain the eigensolutions as the size of the problem doubles. Moreover, this approach also lacks some of the intuitive simplicity of the analysis based on ' $N$ -space'. For these reasons, the determination of eigenvalues and eigenvectors in  $N$ -space for asymmetric non-conservative systems is very desirable. Ma and Caughey [28] (see Theorem 3) have shown that in the special case, when  $\mathbf{M}^{-1}\mathbf{C}$  and  $\mathbf{M}^{-1}\mathbf{K}$  commute, the linear asymmetric non-conservative system (1) can be decoupled by an *equivalence* transformation and hence the  $N$ -space method can be used. But in general, linear non-conservative systems do not satisfy this condition and some kind of approximate methods have to be used for further analysis. Meirovitch and Ryland [29] and Malone *et al.* [30] used a perturbation method to determine the eigensolutions of gyroscopic systems. Recently, Adhikari [31] proposed a Neumann series-based method in which the (complex) right and left eigenvectors of the non-conservative systems are expressed as a series in corresponding undamped eigenvectors. Adhikari's method can be used to obtain the complex eigensolutions up to any desired level of accuracy without using the state-space formalism. This motivates us towards developing procedures to obtain the eigensolution derivatives in  $N$ -space.

We suppose that the variation of interest in the structural system defined by Equation (1) can be described by a set of  $m$  parameters (design variables),  $\mathbf{g} = \{g_1, g_2, \dots, g_m\}^T \in \mathbb{R}^m$ , so that the mass, damping and stiffness matrices become functions of  $\mathbf{g}$ , that is  $\mathbf{M}, \mathbf{C}$  and  $\mathbf{K}: \mathbf{g} \rightarrow \mathbb{R}^{N \times N}$ . Consider two arbitrary elements of the design vector  $\mathbf{g}$ , say  $g_\alpha$  and  $g_\beta$ . For convenience, the notation  $(\bullet)_{,\alpha} \equiv \partial(\bullet)/\partial g_\alpha$  and  $(\bullet)_{,\alpha\beta} \equiv \partial^2(\bullet)/\partial g_\alpha \partial g_\beta$  is used. Our aim is to obtain the first and second derivatives of the eigenvalues  $s_j$ , right eigenvectors  $\mathbf{u}_j$  and left eigenvectors  $\mathbf{v}_j$  with respect to any arbitrary entries of the design vector, or more precisely, want to obtain the expressions for  $s_{j,\alpha}$ ,  $\mathbf{u}_{j,\alpha}$ ,  $\mathbf{v}_{j,\alpha}$ ,  $s_{j,\alpha\beta}$ ,  $\mathbf{u}_{j,\alpha\beta}$  and  $\mathbf{v}_{j,\alpha\beta}$ .

### 3. FIRST-ORDER DERIVATIVES OF THE EIGENVALUES

In this section, we will derive an expression for first-order derivative of the complex eigenvalues of asymmetric non-conservative systems. For notational convenience rewrite

Equations (5) and (6) as

$$\mathbf{F}_j \mathbf{u}_j = \mathbf{0} \tag{23}$$

and

$$\mathbf{v}_j^T \mathbf{F}_j = \mathbf{0}^T \tag{24}$$

where the *regular matrix pencil*

$$\mathbf{F}_j \equiv \mathbf{F}(s_j, \mathbf{g}) = [s_j^2 \mathbf{M} + s_j \mathbf{C} + \mathbf{K}] \in \mathbb{C}^{N \times N} \tag{25}$$

Differentiating Equation (23) with respect to  $g_\alpha$  one obtains

$$\mathbf{F}_{j,\alpha} \mathbf{u}_j + \mathbf{F}_j \mathbf{u}_{j,\alpha} = \mathbf{0} \tag{26}$$

where  $\mathbf{F}_{j,\alpha}$  is equivalent to  $\partial \mathbf{F}_j / \partial g_\alpha$ , and may be obtained by differentiating Equation (25) as

$$\mathbf{F}_{j,\alpha} = \tilde{\mathbf{F}}_{j,\alpha} + s_{j,\alpha} \mathbf{G}_j \tag{27}$$

Here the terms  $\tilde{\mathbf{F}}_{j,\alpha}$  and  $\mathbf{G}_j$  are defined by

$$\begin{aligned} \tilde{\mathbf{F}}_{j,\alpha} &= s_j^2 \mathbf{M}_{,\alpha} + s_j \mathbf{C}_{,\alpha} + \mathbf{K}_{,\alpha} \\ \mathbf{G}_j &= 2s_j \mathbf{M} + \mathbf{C} \end{aligned} \tag{28}$$

Premultiplying Equation (26) by  $\mathbf{v}_j^T$  one obtains the scalar equation

$$\mathbf{v}_j^T \mathbf{F}_{j,\alpha} \mathbf{u}_j = 0 \tag{29}$$

since  $\mathbf{v}_j^T \mathbf{F}_j \mathbf{u}_j = 0$  from Equation (24). Now substituting  $\mathbf{F}_{j,\alpha}$  from Equation (27) into the above equation we obtain the expression for derivative of the  $j$ th complex eigenvalue as

$$s_{j,\alpha} = - \frac{\mathbf{v}_j^T \tilde{\mathbf{F}}_{j,\alpha} \mathbf{u}_j}{\mathbf{v}_j^T \mathbf{G}_j \mathbf{u}_j} = - \frac{\mathbf{v}_j^T [s_j^2 \mathbf{M}_{,\alpha} + s_j \mathbf{C}_{,\alpha} + \mathbf{K}_{,\alpha}] \mathbf{u}_j}{\mathbf{v}_j^T [2s_j \mathbf{M} + \mathbf{C}] \mathbf{u}_j} \tag{30}$$

The derivative of a given eigenvalue requires the knowledge of only the corresponding eigenvalue and right and left eigenvectors under consideration, and thus a complete solution of the eigenproblem is not required. Equation (30) can be used to derive the derivative of eigenvalues for various interesting special cases:

1. *Symmetric conservative system* [1]: In this case,  $\mathbf{M} = \mathbf{M}^T$ ,  $\mathbf{K} = \mathbf{K}^T$  and  $\mathbf{C} = \mathbf{0}$  results in  $s_j = i\omega_j$  where  $\omega_j \in \mathbb{R}$  is the  $j$ th undamped natural frequency and  $\mathbf{v}_j = \mathbf{u}_j \in \mathbb{R}^N$ . Thus, from Equation (30),

$$-2i\omega_j i\omega_{j,\alpha} = (\omega_j^2)_{,\alpha} = \frac{\mathbf{u}_j^T [\mathbf{K}_{,\alpha} - \omega_j^2 \mathbf{M}_{,\alpha}] \mathbf{u}_j}{\mathbf{u}_j^T \mathbf{M} \mathbf{u}_j} \tag{31}$$

which is a well known result.

2. *Asymmetric conservative system* [2, 3]: In this case,  $\mathbf{C} = \mathbf{0}$ , and hence  $\mathbf{u}_j \in \mathbb{R}^N$ ,  $\mathbf{v}_j \in \mathbb{R}^N$  and Equation (30) reduces to

$$(\omega_j^2)_{,\alpha} = \frac{\mathbf{v}_j^T [\mathbf{K}_{,\alpha} - \omega_j^2 \mathbf{M}_{,\alpha}] \mathbf{u}_j}{\mathbf{v}_j^T \mathbf{M} \mathbf{u}_j} \tag{32}$$

3. *Symmetric non-conservative system* [9, 12]: In this case,  $\mathbf{M} = \mathbf{M}^T$ ,  $\mathbf{K} = \mathbf{K}^T$  and  $\mathbf{C} = \mathbf{C}^T$  results in  $\mathbf{v}_j = \mathbf{u}_j$  and reduces Equation (30) to

$$\hat{\lambda}_{j,\alpha} = - \frac{\mathbf{u}_j^T [s_j^2 \mathbf{M}_{,\alpha} + s_j \mathbf{C}_{,\alpha} + \mathbf{K}_{,\alpha}] \mathbf{u}_j}{\mathbf{u}_j^T [2s_j \mathbf{M} + \mathbf{C}] \mathbf{u}_j} \quad (33)$$

Following a similar approach the derivatives of the eigenvalues of undamped and damped gyroscopic systems can also be obtained as special cases of Equation (30).

#### 4. FIRST-ORDER DERIVATIVES OF THE EIGENVECTORS

For asymmetric systems, we need to obtain the derivatives of both right and left eigenvectors. At this stage, it turns out to be useful to perform the calculations in state-space and then relate the results to the right and left eigenvectors of the second-order system. Thus, the derivatives of the right and left eigenvectors of the first-order system with respect to some design variable  $g_\alpha$  will be determined at first.

It is convenient to rewrite Equations (10) and (12) in the following form:

$$\mathcal{P}_j \mathbf{z}_j = \mathbf{0} \quad (34)$$

and

$$\mathbf{y}_j^T \mathcal{P}_j = \mathbf{0}^T \quad (35)$$

where the complex matrix pencil  $\mathcal{P}_j$  is defined as

$$\mathcal{P}_j = s_j \mathcal{A} + \mathcal{B} \in \mathbb{C}^{2N \times 2N} \quad (36)$$

Differentiating Equations (34) and (35) with respect to  $g_\alpha$  one obtains

$$\mathcal{P}_{j,\alpha} \mathbf{z}_j + \mathcal{P}_j \mathbf{z}_{j,\alpha} = \mathbf{0} \quad (37)$$

and

$$\mathbf{y}_j^T \mathcal{P}_{j,\alpha} + \mathbf{y}_{j,\alpha}^T \mathcal{P}_j = \mathbf{0}^T \quad (38)$$

where from Equation (36),

$$\mathcal{P}_{j,\alpha} = s_{j,\alpha} \mathcal{A} + s_j \mathcal{A}_{,\alpha} + \mathcal{B}_{,\alpha} \quad (39)$$

In the above equations,  $\mathbf{z}_{j,\alpha}$  and  $\mathbf{y}_{j,\alpha}$  denote the derivatives of the right and left eigenvectors with respect to  $g_\alpha$  that we want to obtain.

Because it has been already assumed that the system has distinct eigenvalues, the right and left eigenvectors form a *complete* set of vectors. Thus, we can expand  $\mathbf{z}_{j,\alpha}$  and  $\mathbf{y}_{j,\alpha}$  as complex linear combinations of  $\mathbf{z}_l$  and  $\mathbf{y}_l$ , for all  $l = 1, \dots, 2N$ . Thus an expansion of the following form is considered:

$$\mathbf{z}_{j,\alpha} = \sum_{l=1}^{2N} a_{jl}^{(\alpha)} \mathbf{z}_l \quad (40)$$



and

$$\mathbf{y}_{j,\alpha} = \sum_{l=1}^{2N} b_{jl}^{(\alpha)} \mathbf{y}_l \tag{41}$$

Here  $a_{jl}^{(\alpha)}$  and  $b_{jl}^{(\alpha)}$ ,  $\forall l = 1, \dots, 2N$ , are sets of complex constants to be determined. Substituting the assumed expansion for  $\mathbf{z}_{j,\alpha}$  from Equation (40) into Equation (37) and premultiplying by  $\mathbf{y}_k^T$  gives

$$\mathbf{y}_k^T \mathcal{P}_{j,\alpha} \mathbf{z}_j + \sum_{l=1}^{2N} a_{jl}^{(\alpha)} \mathbf{y}_k^T [s_j \mathcal{A} + \mathcal{B}] \mathbf{z}_l = 0 \tag{42}$$

Using the biorthogonality relationship of the right and left eigenvectors described by Equation (17) and also using Equation (18), we obtain

$$a_{jk}^{(\alpha)} = -\frac{\mathbf{y}_k^T \mathcal{P}_{j,\alpha} \mathbf{z}_j}{\mathbf{y}_k^T \mathcal{A} \mathbf{z}_k (s_j - s_k)}, \quad \forall k = 1, \dots, 2N; \quad k \neq j \tag{43}$$

Similarly, substituting the assumed expansion for  $\mathbf{y}_{j,\alpha}$  from Equation (41) into Equation (38), postmultiplying by  $\mathbf{z}_k$  and using the biorthogonality relationship, gives

$$b_{jk}^{(\alpha)} = -\frac{\mathbf{y}_j^T \mathcal{P}_{j,\alpha} \mathbf{z}_k}{\mathbf{y}_k^T \mathcal{A} \mathbf{z}_k (s_j - s_k)}, \quad \forall k = 1, \dots, 2N; \quad k \neq j \tag{44}$$

The expressions for  $a_{jk}^{(\alpha)}$  and  $b_{jk}^{(\alpha)}$  derived above are not valid when  $k = j$ . To obtain  $a_{jj}^{(\alpha)}$  and  $b_{jj}^{(\alpha)}$  we begin by differentiating Equation (19)

$$\mathbf{y}_{j,\alpha}^T \mathcal{A} \mathbf{z}_j + \mathbf{y}_j^T \mathcal{A}_{,\alpha} \mathbf{z}_j + \mathbf{y}_j^T \mathcal{A} \mathbf{z}_{j,\alpha} = 0 \tag{45}$$

Substituting the assumed expansion for  $\mathbf{z}_{j,\alpha}$  and  $\mathbf{y}_{j,\alpha}$  from Equations (40) and (41) and also making use of the biorthogonality property, one has

$$a_{jj}^{(\alpha)} + b_{jj}^{(\alpha)} = -\frac{\mathbf{y}_j^T \mathcal{A}_{,\alpha} \mathbf{z}_j}{\mathbf{y}_j^T \mathcal{A} \mathbf{z}_j} \tag{46}$$

The second equation for  $a_{jj}^{(\alpha)}$  and  $b_{jj}^{(\alpha)}$  comes from the relative normalization expression for the left and right eigenvectors, Equation (22). It is clear that if the  $n_j$ th elements of the left and right eigenvectors remain equal then so do the corresponding elements of the derivatives. Thus,

$$\{\mathbf{u}_{j,\alpha}\}_{n_j} = \{\mathbf{v}_{j,\alpha}\}_{n_j} = \{\mathbf{z}_{j,\alpha}\}_{n_j} = \{\mathbf{y}_{j,\alpha}\}_{n_j} \tag{47}$$

Substituting the assumed expressions for  $\mathbf{z}_{j,\alpha}$  and  $\mathbf{y}_{j,\alpha}$  from Equations (40) and (41), into Equation (47), gives

$$b_{jj}^{(\alpha)} - a_{jj}^{(\alpha)} = \frac{1}{\{\mathbf{y}_j\}_{n_j}} \sum_{\substack{k=1 \\ k \neq j}}^{2N} [a_{jk}^{(\alpha)} \{\mathbf{z}_k\}_{n_j} - b_{jk}^{(\alpha)} \{\mathbf{y}_k\}_{n_j}] \tag{48}$$

Since all the quantities on the right-hand side of (48) are known, the constants  $a_{jj}^{(\alpha)}$  and  $b_{jj}^{(\alpha)}$  are easily computed from Equations (46) and (48).

The constants  $a_{jk}^{(\alpha)}, b_{jk}^{(\alpha)}$ ,  $\forall k = 1, \dots, 2N$ , expressed in Equations (43), (44), (46) and (48) are not very useful because they are in terms of right and left eigenvectors of the first-order system. In order to obtain a relationship in terms of the eigenvectors of the second-order system we utilize the expressions of  $\mathbf{z}_j$  and  $\mathbf{y}_j$  in Equations (11) and (16), respectively. First consider Equation (43). Substituting  $\mathcal{P}_{j,\alpha}$  from Equation (39) and using the biorthogonality relationship in Equation (17), when  $k \neq j+N$  the numerator on the right side of this equation is

$$\begin{aligned} \mathbf{y}_k^T \mathcal{P}_{j,\alpha} \mathbf{z}_j &= \mathbf{y}_k^T [s_j \mathcal{A}_{,\alpha} + \mathcal{B}_{,\alpha}] \mathbf{z}_j \\ &= \begin{Bmatrix} \mathbf{v}_k \\ s_k \mathbf{v}_k \end{Bmatrix}^T \begin{bmatrix} s_j \mathbf{C}_{,\alpha} + \mathbf{K}_{,\alpha} & s_j \mathbf{M}_{,\alpha} \\ s_j \mathbf{M}_{,\alpha} & -\mathbf{M}_{,\alpha} \end{bmatrix} \begin{Bmatrix} \mathbf{u}_j \\ s_j \mathbf{u}_j \end{Bmatrix} \\ &= \mathbf{v}_k^T [s_j^2 \mathbf{M}_{,\alpha} + s_j \mathbf{C}_{,\alpha} + \mathbf{K}_{,\alpha}] \mathbf{u}_j \end{aligned} \quad (49)$$

Utilizing the expression of the normalization in (19) from Equation (43) we have

$$a_{jk}^{(\alpha)} = -\gamma_k \frac{\mathbf{v}_k^T [s_j^2 \mathbf{M}_{,\alpha} + s_j \mathbf{C}_{,\alpha} + \mathbf{K}_{,\alpha}] \mathbf{u}_j}{(s_j - s_k)}, \quad \forall k = 1, \dots, 2N, \quad k \neq j, j+N \quad (50)$$

When  $k = j+N$ , from the ordering of the eigenvalues in Equation (4) we have  $s_k = s_j^*$  and  $\mathbf{y}_k = \mathbf{y}_j^*$ . Recalling the expression of  $s_{j,\alpha}$  in Equation (30), the numerator on the right side of Equation (43) is

$$\begin{aligned} \mathbf{y}_k^T \mathcal{P}_{j,\alpha} \mathbf{z}_j &= \mathbf{y}_j^{*T} [s_j \mathcal{A}_{,\alpha} + \mathcal{B}_{,\alpha}] \mathbf{z}_j + s_{j,\alpha} \mathbf{y}_j^{*T} \mathcal{A} \mathbf{z}_j \\ &= \mathbf{v}_j^{*T} [s_j^2 \mathbf{M}_{,\alpha} + s_j \mathbf{C}_{,\alpha} + \mathbf{K}_{,\alpha}] \mathbf{u}_j - \mathbf{v}_j^T [s_j^2 \mathbf{M}_{,\alpha} + s_j \mathbf{C}_{,\alpha} + \mathbf{K}_{,\alpha}] \mathbf{u}_j \frac{\mathbf{v}_j^{*T} [(s_j + s_j^*) \mathbf{M} + \mathbf{C}] \mathbf{u}_j}{\mathbf{v}_j^T [2s_j \mathbf{M} + \mathbf{C}] \mathbf{u}_j} \\ &= (\mathbf{v}_j^* - \eta_{vj} \mathbf{v}_j)^T [s_j^2 \mathbf{M}_{,\alpha} + s_j \mathbf{C}_{,\alpha} + \mathbf{K}_{,\alpha}] \mathbf{u}_j \end{aligned} \quad (51)$$

where the scalar

$$\eta_{vj} = \frac{\mathbf{v}_j^{*T} [(s_j + s_j^*) \mathbf{M} + \mathbf{C}] \mathbf{u}_j}{\mathbf{v}_j^T [2s_j \mathbf{M} + \mathbf{C}] \mathbf{u}_j} = \gamma_j \mathbf{v}_j^{*T} [(s_j + s_j^*) \mathbf{M} + \mathbf{C}] \mathbf{u}_j \quad (52)$$

Using this relationship, Equation (43) becomes

$$a_{jj+N}^{(\alpha)} = i\gamma_j^* \frac{(\mathbf{v}_j^* - \eta_{vj} \mathbf{v}_j)^T [s_j^2 \mathbf{M}_{,\alpha} + s_j \mathbf{C}_{,\alpha} + \mathbf{K}_{,\alpha}] \mathbf{u}_j}{2\Im(s_j)} \quad (53)$$

where  $\Im(\bullet)$  denotes the imaginary part of  $(\bullet)$ . Following a similar procedure, Equation (44) becomes

$$b_{jk}^{(\alpha)} = -\gamma_k \frac{\mathbf{v}_j^T [s_j^2 \mathbf{M}_{,\alpha} + s_j \mathbf{C}_{,\alpha} + \mathbf{K}_{,\alpha}] \mathbf{u}_k}{(s_j - s_k)}, \quad \forall k = 1, \dots, 2N, \quad k \neq j, j+N \quad (54)$$

and

$$b_{jj+N}^{(\alpha)} = i\gamma_j^* \frac{\mathbf{v}_j^T [s_j^2 \mathbf{M}_{,\alpha} + s_j \mathbf{C}_{,\alpha} + \mathbf{K}_{,\alpha}] (\mathbf{u}_j^* - \eta_{u_j} \mathbf{u}_j)}{2\Im(s_j)} \tag{55}$$

where the scalar  $\eta_{u_j}$  is

$$\eta_{u_j} = \frac{\mathbf{v}_j^T [(s_j + s_j^*) \mathbf{M} + \mathbf{C}] \mathbf{u}_j^*}{\mathbf{v}_j^T [2s_j \mathbf{M} + \mathbf{C}] \mathbf{u}_j} = \gamma_j \mathbf{v}_j^T [(s_j + s_j^*) \mathbf{M} + \mathbf{C}] \mathbf{u}_j^* \tag{56}$$

From Equations (46) and (48) we also have

$$a_{jj}^{(\alpha)} + b_{jj}^{(\alpha)} = -\gamma_j \mathbf{v}_j^T [2s_j \mathbf{M}_{,\alpha} + \mathbf{C}_{,\alpha}] \mathbf{u}_j \tag{57}$$

and

$$b_{jj}^{(\alpha)} - a_{jj}^{(\alpha)} = \frac{1}{\{\mathbf{v}_j\}_{n_j}} \sum_{\substack{k=1 \\ k \neq j}}^{2N} [a_{jk}^{(\alpha)} \{\mathbf{u}_k\}_{n_j} - b_{jk}^{(\alpha)} \{\mathbf{v}_k\}_{n_j}] \tag{58}$$

Equations (50), (54), (57) and (58) completely determine  $a_{jk}^{(\alpha)}, b_{jk}^{(\alpha)}, \forall k = 1, \dots, 2N$ , from the right and left eigenvectors of the second-order system and derivatives of the system property matrices.

It is interesting to observe that if the system is undamped, that is, when  $\mathbf{u}_j^* = \mathbf{u}_j, \mathbf{v}_j^* = \mathbf{v}_j$  and  $\mathbf{C} = \mathbf{0}$ , the scalar constants are unity,  $\eta_{u_j} = \eta_{v_j} = 1$ , which implies that  $a_{jj+N}^{(\alpha)} = b_{jj+N}^{(\alpha)} = 0$ .

Now returning to the assumed expansion of  $\mathbf{z}_{j,\alpha}$  and  $\mathbf{y}_{j,\alpha}$  in Equations (40) and (41) it may be noted that they are vector equations with  $2N$  rows. In view of the expressions for  $\mathbf{z}_j$  and  $\mathbf{y}_j$  in Equations (11) and (16), the first  $N$  rows are the derivatives of right and left eigenvectors of the second-order system. Thus, taking only the first  $N$  rows of Equation (40) and recalling the order of the eigenvalues in (4) one obtains

$$\mathbf{u}_{j,\alpha} = a_{jj}^{(\alpha)} \mathbf{u}_j + a_{jj+N}^{(\alpha)} \mathbf{u}_j^* + \sum_{\substack{k=1 \\ k \neq j}}^N [a_{jk}^{(\alpha)} \mathbf{u}_k + a_{jk+N}^{(\alpha)} \mathbf{u}_k^*] \tag{59}$$

Similarly, taking only the first  $N$  rows of Equation (41) the derivative of left eigenvector of the second-order system can be obtained as

$$\mathbf{v}_{j,\alpha} = b_{jj}^{(\alpha)} \mathbf{v}_j + b_{jj+N}^{(\alpha)} \mathbf{v}_j^* + \sum_{\substack{k=1 \\ k \neq j}}^N [b_{jk}^{(\alpha)} \mathbf{v}_k + b_{jk+N}^{(\alpha)} \mathbf{v}_k^*] \tag{60}$$

The expressions derived above relate the derivatives of the right and left eigenvectors to the derivative of the system property matrices and the eigenvectors of the second-order system. The (complex) eigenvectors of the second-order system can be obtained *exactly* from the (real) eigenvectors of the corresponding undamped system [31]. It in turn indicates that first-order eigen-sensitivity analysis of asymmetric non-conservative systems can be performed simply by a proper ‘postprocessing’ of the eigensolutions of the corresponding conservative systems. Because the state-space formalism is avoided this approach provides significant reduction in computational effort. In effect, we need to solve only two  $N$ th-order eigenvalue

problems instead of solving two  $2N$ th-order eigenvalue problems. Moreover, this approach also provide good physical insight as the simplicity of the  $N$ -space eigenvectors are preserved. Equations (59) and (60) can be used to obtain the derivative of eigenvectors for various useful special cases:

1. *Symmetric conservative system* [1]: In this case,  $\mathbf{M}=\mathbf{M}^T$ ,  $\mathbf{K}=\mathbf{K}^T$  and  $\mathbf{C}=\mathbf{0}$ . The eigenvalues are  $s_j=i\omega_j$  where  $\omega_j$  is the  $j$ th undamped natural frequency and  $\mathbf{v}_j=\mathbf{u}_j=\mathbf{v}_j^*=\mathbf{u}_j^* \in \mathbb{R}^N$ . As explained before the coefficient associated with  $\mathbf{u}_j^*$  in Equation (59) vanishes and with usual mass normalization  $\gamma_j=1/2i\omega_j$ . Using these Equation (59) gives

$$\begin{aligned} \mathbf{u}_{j,\alpha} &= -\frac{1}{2} \frac{1}{2i\omega_j} (2i\omega_j \mathbf{u}_j^T \mathbf{M}_{,\alpha} \mathbf{u}_j) \mathbf{u}_j - \sum_{\substack{k=1 \\ k \neq j}}^N \frac{\mathbf{u}_k^T [\mathbf{K}_{,\alpha} - \omega_j^2 \mathbf{M}_{,\alpha}] \mathbf{u}_j}{2i\omega_k} \left[ \frac{1}{i\omega_j - i\omega_k} - \frac{1}{i\omega_j + i\omega_k} \right] \mathbf{u}_k \\ &= -\frac{1}{2} (\mathbf{u}_j^T \mathbf{M}_{,\alpha} \mathbf{u}_j) \mathbf{u}_j + \sum_{\substack{k=1 \\ k \neq j}}^N \frac{\mathbf{u}_k^T [\mathbf{K}_{,\alpha} - \omega_j^2 \mathbf{M}_{,\alpha}] \mathbf{u}_j}{\omega_j^2 - \omega_k^2} \mathbf{u}_k \end{aligned} \tag{61}$$

which is a well-known result.

2. *Asymmetric conservative system* [2, 3]: In this case,  $\mathbf{C}=\mathbf{0}$ ,  $\mathbf{u}_j \in \mathbb{R}^N$  and  $\mathbf{v}_j \in \mathbb{R}^N$ . Equations (59) and (60) reduce to

$$\mathbf{u}_{j,\alpha} = -\frac{1}{2} (\mathbf{v}_j^T \mathbf{M}_{,\alpha} \mathbf{u}_j) \mathbf{u}_j + \sum_{\substack{k=1 \\ k \neq j}}^N \frac{\mathbf{v}_k^T [\mathbf{K}_{,\alpha} - \omega_j^2 \mathbf{M}_{,\alpha}] \mathbf{u}_j}{\omega_j^2 - \omega_k^2} \mathbf{u}_k \tag{62}$$

and

$$\mathbf{v}_{j,\alpha} = -\frac{1}{2} (\mathbf{v}_j^T \mathbf{M}_{,\alpha} \mathbf{u}_j) \mathbf{v}_j + \sum_{\substack{k=1 \\ k \neq j}}^N \frac{\mathbf{v}_j^T [\mathbf{K}_{,\alpha} - \omega_j^2 \mathbf{M}_{,\alpha}] \mathbf{u}_k}{\omega_j^2 - \omega_k^2} \mathbf{v}_k \tag{63}$$

3. *Symmetric non-conservative system* [12]: In this case,  $\mathbf{M}=\mathbf{M}^T$ ,  $\mathbf{K}=\mathbf{K}^T$  and  $\mathbf{C}=\mathbf{C}^T$ , and thus  $\mathbf{v}_j=\mathbf{u}_j$  and reduces expression (59) to

$$\begin{aligned} \mathbf{u}_{j,\alpha} &= -\frac{1}{2} \gamma_j (\mathbf{u}_j^T \tilde{\mathbf{G}}_{j,\alpha} \mathbf{u}_j) \mathbf{u}_j - \gamma_j^* \frac{(\mathbf{u}_j^* - \eta_{vj} \mathbf{v}_j)^T \tilde{\mathbf{F}}_{j,\alpha} \mathbf{u}_j}{2\Im(s_j)} \mathbf{u}_j^* \\ &\quad - \sum_{\substack{k=1 \\ k \neq j}}^N \left[ \gamma_k \frac{\mathbf{u}_k^T \tilde{\mathbf{F}}_{j,\alpha} \mathbf{u}_j}{s_j - s_k} \mathbf{u}_k + \gamma_k^* \frac{\mathbf{u}_k^{*T} \tilde{\mathbf{F}}_{j,\alpha} \mathbf{u}_j}{s_j - s_k^*} \mathbf{u}_k^* \right] \end{aligned} \tag{64}$$

The term associated with  $\mathbf{u}_j^*$ , however, has not been explicitly obtained in Reference [12]. Following similar approach derivative of the right and left eigenvectors for undamped and damped gyroscopic systems can also be obtained as special cases of Equations (59) and (60).

### 5. SECOND-ORDER DERIVATIVES OF THE EIGENVALUES

In this section, we derive an expression for the joint derivatives of the complex eigenvalues with respect to two independent design parameters, say  $g_\alpha$  and  $g_\beta$ . Differentiating Equation (26)

with respect to  $g_\beta$  one obtains

$$\mathbf{F}_{j,\alpha\beta}\mathbf{u}_j + \mathbf{F}_{j,\alpha}\mathbf{u}_{j,\beta} + \mathbf{F}_{j,\beta}\mathbf{u}_{j,\alpha} + \mathbf{F}_j\mathbf{u}_{j,\alpha\beta} = 0 \tag{65}$$

The term  $\mathbf{F}_{j,\alpha\beta}$  appearing in the above equation can be obtained by using Equations (27) and (28) as

$$\begin{aligned} \mathbf{F}_{j,\alpha\beta} &= [\mathbf{F}_{j,\alpha}]_{,\beta} = [\tilde{\mathbf{F}}_{j,\alpha} + s_{j,\alpha}\mathbf{G}_j]_{,\beta} \\ &= [\tilde{\mathbf{F}}_{j,\alpha}]_{,\beta} + s_{j,\alpha}\mathbf{G}_{j,\beta} + s_{j,\alpha\beta}\mathbf{G}_j \end{aligned} \tag{66}$$

where the terms  $[\tilde{\mathbf{F}}_{j,\alpha}]_{,\beta}$  and  $\mathbf{G}_{j,\beta}$  are

$$[\tilde{\mathbf{F}}_{j,\alpha}]_{,\beta} = \tilde{\mathbf{F}}_{j,\alpha\beta} + s_{j,\beta}\tilde{\mathbf{G}}_{j,\alpha}$$

with

$$\begin{aligned} \tilde{\mathbf{F}}_{j,\alpha\beta} &= s_j^2\mathbf{M}_{,\alpha\beta} + s_j\mathbf{C}_{,\alpha\beta} + \mathbf{K}_{,\alpha\beta} \\ \tilde{\mathbf{G}}_{j,\alpha} &= 2s_j\mathbf{M}_{,\alpha} + \mathbf{C}_{,\alpha} \end{aligned} \tag{67}$$

and

$$\mathbf{G}_{j,\beta} = \tilde{\mathbf{G}}_{j,\beta} + 2s_{j,\beta}\mathbf{M}$$

Combining Equations (66) and (67),  $\mathbf{F}_{j,\alpha\beta}$  is obtained as

$$\mathbf{F}_{j,\alpha\beta} = \tilde{\mathbf{F}}_{j,\alpha\beta} + s_{j,\beta}\tilde{\mathbf{G}}_{j,\alpha} + s_{j,\alpha}\tilde{\mathbf{G}}_{j,\beta} + 2s_{j,\alpha}s_{j,\beta}\mathbf{M} + s_{j,\alpha\beta}\mathbf{G}_j \tag{68}$$

Premultiplying Equation (65) by  $\mathbf{v}_j^T$  yields

$$\mathbf{v}_j^T\mathbf{F}_{j,\alpha\beta}\mathbf{u}_j + \mathbf{v}_j^T\mathbf{F}_{j,\alpha}\mathbf{u}_{j,\beta} + \mathbf{v}_j^T\mathbf{F}_{j,\beta}\mathbf{u}_{j,\alpha} + \mathbf{v}_j^T\mathbf{F}_j\mathbf{u}_{j,\alpha\beta} = 0 \tag{69}$$

By virtue of Equation (24), the last term of this equation is zero. Using Equation (27) for  $\mathbf{F}_{j,\alpha}$  and  $\mathbf{F}_{j,\beta}$  we can rewrite Equation (69) as

$$\mathbf{v}_j^T\mathbf{F}_{j,\alpha\beta}\mathbf{u}_j + \mathbf{v}_j^T[\tilde{\mathbf{F}}_{j,\alpha} + s_{j,\alpha}\mathbf{G}_j]\mathbf{u}_{j,\beta} + \mathbf{v}_j^T[\tilde{\mathbf{F}}_{j,\beta} + s_{j,\beta}\mathbf{G}_j]\mathbf{u}_{j,\alpha} = 0 \tag{70}$$

Now substituting  $\mathbf{F}_{j,\alpha\beta}$  from Equation (68) into the above equation we obtain the expression for the joint derivative of the  $j$ th complex eigenvalue as with respect to  $g_\alpha$  and  $g_\beta$  as

$$\begin{aligned} s_{j,\alpha\beta} &= -\frac{1}{\mathbf{v}_j^T\mathbf{G}_j\mathbf{u}_j} [\mathbf{v}_j^T(\tilde{\mathbf{F}}_{j,\alpha\beta} + s_{j,\alpha}\tilde{\mathbf{G}}_{j,\beta} + s_{j,\beta}\tilde{\mathbf{G}}_{j,\alpha})\mathbf{u}_j \\ &\quad + \mathbf{v}_j^T(\tilde{\mathbf{F}}_{j,\alpha} + s_{j,\alpha}\mathbf{G}_j)\mathbf{u}_{j,\beta} + \mathbf{v}_j^T(\tilde{\mathbf{F}}_{j,\beta} + s_{j,\beta}\mathbf{G}_j)\mathbf{u}_{j,\alpha} + 2s_{j,\alpha}s_{j,\beta}\mathbf{v}_j^T\mathbf{M}\mathbf{u}_j] \end{aligned} \tag{71}$$

All the terms in the right side of this equation are known, and are related to the first-order derivative of the eigensolutions and the derivatives of the mass, damping and stiffness matrices with respect to the parameters  $g_\alpha$  and  $g_\beta$ . The first-order derivatives of the complex eigenvalues and eigenvectors have to be obtained from Equations (30) and (59) derived before. Second-order derivatives of the eigenvalues of undamped systems have been studied in References

[32, 3, 5, 33]. Their results may be obtained as a special case of Equation (71) by substituting  $\mathbf{C} = \mathbf{0}$  and utilizing the usual mass orthogonality of the real undamped modes.

One particular special case which is useful in many applications is the double derivative of the eigenvalues with respect to any one parameter, where the system matrices are linear functions of  $\mathbf{g}$ . Thus, setting  $\alpha = \beta$  and setting  $\tilde{\tilde{\mathbf{F}}}_{j,\alpha\beta}$  equal to zero, from Equation (71) we obtain

$$s_{j,\alpha\alpha} = -\frac{2}{\mathbf{v}_j^T \mathbf{G}_j \mathbf{u}_j} [\mathbf{v}_j^T \tilde{\mathbf{F}}_{j,\alpha} \mathbf{u}_{j,\alpha} + s_{j,\alpha} (\mathbf{v}_j^T \tilde{\mathbf{G}}_{j,\alpha} \mathbf{u}_j + \mathbf{v}_j^T \mathbf{G}_j \mathbf{u}_{j,\alpha}) + s_{j,\alpha}^2 \mathbf{v}_j^T \mathbf{M} \mathbf{u}_j] \quad (72)$$

Similar problems have been discussed by Brandon [15] in the context of undamped systems. One may verify that for undamped systems, Equation (72) reduces to the equivalent expression derived in Reference [15].

## 6. SECOND-ORDER DERIVATIVES OF THE EIGENVECTORS

In this section we derive an expression for the joint derivatives of the right and left eigenvectors of the second-order system with respect to two independent design parameters, say  $g_\alpha$  and  $g_\beta$ . Since it has been assumed already that the system has distinct eigenvalues, the right and left eigenvectors form a *complete* set of vectors. Thus we can expand  $\mathbf{z}_{j,\alpha\beta}$  and  $\mathbf{y}_{j,\alpha\beta}$  as complex linear combinations of  $\mathbf{z}_l$  and  $\mathbf{y}_l$ , for all  $l = 1, \dots, 2N$ , as

$$\mathbf{z}_{j,\alpha\beta} = \sum_{l=1}^{2N} c_{jl}^{(\alpha\beta)} \mathbf{z}_l \quad (73)$$

and

$$\mathbf{y}_{j,\alpha\beta} = \sum_{l=1}^{2N} d_{jl}^{(\alpha\beta)} \mathbf{y}_l \quad (74)$$

Here  $c_{jl}^{(\alpha)}$  and  $d_{jl}^{(\alpha)}$ ,  $\forall l = 1, \dots, 2N$ , are sets of complex constants to be determined. Differentiating Equation (37) with respect to  $g_\beta$  one obtains

$$\mathcal{P}_{j,\alpha\beta} \mathbf{z}_j + \mathcal{P}_{j,\alpha} \mathbf{z}_{j,\beta} + \mathcal{P}_{j,\beta} \mathbf{z}_{j,\alpha} + \mathcal{P}_j \mathbf{z}_{j,\alpha\beta} = 0 \quad (75)$$

Substituting the assumed expansion of  $\mathbf{z}_{j,\alpha\beta}$  from Equation (73) into this equation and pre-multiplying by  $\mathbf{y}_k^T$  one obtains

$$\mathbf{y}_k^T \mathcal{P}_{j,\alpha\beta} \mathbf{z}_j + \mathbf{y}_k^T \mathcal{P}_{j,\alpha} \mathbf{z}_{j,\beta} + \mathbf{y}_k^T \mathcal{P}_{j,\beta} \mathbf{z}_{j,\alpha} + \sum_{l=1}^{2N} c_{jl}^{(\alpha\beta)} \mathbf{y}_k^T [s_j \mathcal{A} + \mathcal{B}] \mathbf{z}_l = 0 \quad (76)$$

Using the biorthogonality relationship between the right and left eigenvectors described by Equation (17) and also in view of Equation (18), we obtain

$$c_{jk}^{(\alpha\beta)} = -\frac{\mathbf{y}_k^T \mathcal{P}_{j,\alpha\beta} \mathbf{z}_j + \mathbf{y}_k^T \mathcal{P}_{j,\alpha} \mathbf{z}_{j,\beta} + \mathbf{y}_k^T \mathcal{P}_{j,\beta} \mathbf{z}_{j,\alpha}}{\mathbf{y}_k^T \mathcal{A} \mathbf{z}_k (s_j - s_k)}, \quad \forall k = 1, \dots, 2N, \quad k \neq j \quad (77)$$

Similarly, differentiating Equation (35) successively with respect to  $g_\alpha$  and  $g_\beta$ , substituting the assumed expansion of  $\mathbf{y}_{j,\alpha\beta}$  from Equation (74) and then postmultiplying by  $\mathbf{z}_k^T$  one obtains

$$d_{jk}^{(\alpha\beta)} = - \frac{\mathbf{y}_j^T \mathcal{P}_{j,\alpha\beta} \mathbf{z}_k + \mathbf{y}_{j,\beta}^T \mathcal{P}_{j,\alpha} \mathbf{z}_k + \mathbf{y}_{j,\alpha}^T \mathcal{P}_{j,\beta} \mathbf{z}_k}{\mathbf{y}_k^T \mathcal{A} \mathbf{z}_k (s_j - s_k)}, \quad \forall k = 1, \dots, 2N, \quad k \neq j \tag{78}$$

The constants  $c_{jk}^{(\alpha\beta)}$  and  $d_{jk}^{(\alpha\beta)}$  given above are not very useful since they are in terms of left and right eigenvectors of the first-order system. Following the procedure in the appendix these constants can be related to the left and right eigenvectors of second-order system and their first derivatives.

To obtain  $c_{jj}^{(\alpha\beta)}$  and  $d_{jj}^{(\alpha\beta)}$  we first differentiate Equation (45) by  $g_\beta$  and obtain

$$\begin{aligned} &\mathbf{y}_{j,\alpha\beta}^T \mathcal{A} \mathbf{z}_j + \mathbf{y}_{j,\alpha}^T \mathcal{A}_{,\beta} \mathbf{z}_j + \mathbf{y}_{j,\alpha}^T \mathcal{A} \mathbf{z}_{j,\beta} \mathbf{y}_{j,\beta}^T \mathcal{A}_{,\alpha} \mathbf{z}_j \\ &+ \mathbf{y}_j^T \mathcal{A}_{,\alpha\beta} \mathbf{z}_j + \mathbf{y}_j^T \mathcal{A}_{,\alpha} \mathbf{z}_{j,\beta} + \mathbf{y}_{j,\beta}^T \mathcal{A} \mathbf{z}_{j,\alpha} + \mathbf{y}_j^T \mathcal{A}_{,\beta} \mathbf{z}_{j,\alpha} + \mathbf{y}_j^T \mathcal{A} \mathbf{z}_{j,\alpha\beta} = 0 \end{aligned} \tag{79}$$

Substituting the assumed expansion of  $\mathbf{z}_{j,\alpha\beta}$  and  $\mathbf{y}_{j,\alpha\beta}$  from Equations (73) and (74) and also making use of the biorthogonality property,

$$\begin{aligned} c_{jj}^{(\alpha\beta)} + d_{jj}^{(\alpha\beta)} &= - \frac{1}{\mathbf{y}_j^T \mathcal{A} \mathbf{z}_j} [\mathbf{y}_j^T \mathcal{A}_{,\alpha\beta} \mathbf{z}_j + \mathbf{y}_{j,\beta}^T \mathcal{A}_{,\alpha} \mathbf{z}_j \\ &+ \mathbf{y}_{j,\beta}^T \mathcal{A} \mathbf{z}_{j,\alpha} + \mathbf{y}_{j,\alpha}^T \mathcal{A}_{,\beta} \mathbf{z}_j + \mathbf{y}_{j,\alpha}^T \mathcal{A} \mathbf{z}_{j,\beta} + \mathbf{y}_j^T \mathcal{A}_{,\alpha} \mathbf{z}_{j,\beta} + \mathbf{y}_j^T \mathcal{A}_{,\beta} \mathbf{z}_{j,\alpha}] \end{aligned} \tag{80}$$

From the above equation it may be noted that  $c_{jj}^{(\alpha\beta)}$  and  $d_{jj}^{(\alpha\beta)}$  are not derived uniquely but defined as a joint sum. As for the first-order derivatives of the eigenvectors, the second equation for these constants comes from the relative normalization expression for the left and right eigenvectors, Equation (22). It is clear that if the  $n_j$ th elements of the left and right eigenvectors remain equal then so do the corresponding elements of the second-order derivatives. Thus,

$$\{\mathbf{u}_{j,\alpha\beta}\}_{n_j} = \{\mathbf{v}_{j,\alpha\beta}\}_{n_j} = \{\mathbf{z}_{j,\alpha\beta}\}_{n_j} = \{\mathbf{y}_{j,\alpha\beta}\}_{n_j} \tag{81}$$

Substituting the assumed expressions for  $\mathbf{z}_{j,\alpha\beta}$  and  $\mathbf{y}_{j,\alpha\beta}$  from Equations (73) and (74), into Equation (81), gives

$$c_{jj}^{(\alpha\beta)} - d_{jj}^{(\alpha\beta)} = \frac{1}{\{\mathbf{y}_j\}_{n_j}} \sum_{\substack{k=1 \\ k \neq j}}^{2N} [c_{jk}^{(\alpha\beta)} \{\mathbf{z}_k\}_{n_j} - d_{jk}^{(\alpha\beta)} \{\mathbf{y}_k\}_{n_j}] \tag{82}$$

Since all the quantities on the right-hand side of (82) are known, the constants  $c_{jj}^{(\alpha\beta)}$  and  $d_{jj}^{(\alpha\beta)}$  are easily computed from Equations (80) and (82).

The values of the constants  $c_{jj}^{(\alpha\beta)}$  and  $d_{jj}^{(\alpha\beta)}$  have been expressed in terms of the eigenvectors of the first-order system and thus, cannot be used directly for  $N$ -space-based analysis. Following the procedure outlined in the appendix these constants can be related to the right and left eigenvectors of second-order system and their first derivatives.

Now following an approach similar to that used before to determine the first derivative, one may consider only the first  $N$  rows of Equation (73) to obtain the second derivative of

right eigenvectors of the second-order system. Using the fact that the eigenvalues occur in complex conjugate pairs  $\mathbf{u}_{j,\alpha\beta}$  can be expressed as

$$\mathbf{u}_{j,\alpha\beta} = c_{jj}^{(\alpha\beta)} \mathbf{u}_j + c_{jj+N}^{(\alpha\beta)} \mathbf{u}_j^* + \sum_{\substack{k=1 \\ k \neq j}}^N [c_{jk}^{(\alpha\beta)} \mathbf{u}_k + c_{jk+N}^{(\alpha\beta)} \mathbf{u}_k^*] \quad (83)$$

Again, considering only the first  $N$  rows of Equation (74) and following a similar procedure, the joint derivatives of the left eigenvectors of the second-order system with respect to  $g_\alpha$  and  $g_\beta$  can be expressed as

$$\mathbf{v}_{j,\alpha\beta} = d_{jj}^{(\alpha\beta)} \mathbf{v}_j + d_{jj+N}^{(\alpha\beta)} \mathbf{v}_j^* + \sum_{\substack{k=1 \\ k \neq j}}^N [d_{jk}^{(\alpha\beta)} \mathbf{v}_k + d_{jk+N}^{(\alpha\beta)} \mathbf{v}_k^*] \quad (84)$$

All the terms in the right-hand side of Equations (83) and (84) are related to the first-order derivatives of the eigensolutions and the derivatives of the mass, damping and stiffness matrices with respect to the parameters  $g_\alpha$  and  $g_\beta$ . The first-order derivatives of the complex eigenvalues and eigenvectors are obtained from Sections 3 and 4. The expressions of the second-order derivative of the complex eigenvectors derived here are very general in nature—undamped systems, symmetric non-conservative systems, damped and undamped gyroscopic systems may be considered as special cases. One particular case that is useful in many applications is the double derivative of the eigenvectors with respect to any one parameter, and where the system matrices are linear functions of  $\mathbf{g}$ . For this case, the forms of Equations (83) and (84) will still be valid but the values of the constants  $c_{jk}^{(\alpha\beta)}$  and  $d_{jk}^{(\alpha\beta)}$  appearing in these equation will be different. These may be obtained by setting  $\alpha = \beta$  and setting  $\tilde{\mathbf{F}}_{j,\alpha\beta}$  equal to zero. Thus, we have

$$\begin{aligned} c_{jk}^{(\alpha\alpha)} = & -\frac{2\gamma_k}{(s_j - s_k)} [\mathbf{v}_k^T \tilde{\mathbf{F}}_{j,\alpha} \mathbf{u}_{j,\alpha} + (s_j + s_k) s_{j,\alpha} \mathbf{v}_k^T \mathbf{M} \mathbf{u}_{j,\alpha} \\ & + s_{j,\alpha} (\mathbf{v}_k^T \mathbf{C}_{,\alpha} \mathbf{u}_j + \mathbf{v}_k^T \mathbf{C} \mathbf{u}_{j,\alpha}) + 2s_j s_{j,\alpha} \mathbf{v}_k^T \mathbf{M}_{,\alpha} \mathbf{u}_j + 2s_{j,\alpha}^2 \mathbf{v}_k^T \mathbf{M} \mathbf{u}_j], \quad \forall k = 1, \dots, 2N, \quad k \neq j \end{aligned} \quad (85)$$

and

$$\begin{aligned} d_{jk}^{(\alpha\alpha)} = & -\frac{2\gamma_k}{(s_j - s_k)} [\mathbf{v}_{j,\alpha}^T \tilde{\mathbf{F}}_{j,\alpha} \mathbf{u}_k + (s_j + s_k) s_{j,\alpha} \mathbf{v}_{j,\alpha}^T \mathbf{M} \mathbf{u}_k \\ & + s_{j,\alpha} (\mathbf{v}_j^T \mathbf{C}_{,\alpha} \mathbf{u}_k + \mathbf{v}_{j,\alpha}^T \mathbf{C} \mathbf{u}_k) + 2s_j s_{j,\alpha} \mathbf{v}_j^T \mathbf{M}_{,\alpha} \mathbf{u}_k + 2s_{j,\alpha}^2 \mathbf{v}_j^T \mathbf{M} \mathbf{u}_k], \quad \forall k = 1, \dots, 2N, \quad k \neq j \end{aligned} \quad (86)$$

The sum of constants,  $c_{jj}^{(\alpha\alpha)} + d_{jj}^{(\alpha\alpha)}$  is given by

$$\begin{aligned} c_{jj}^{(\alpha\alpha)} + d_{jj}^{(\alpha\alpha)} = & -2\gamma_j \{ \mathbf{v}_{j,\alpha}^T \tilde{\mathbf{G}}_{j,\alpha} \mathbf{u}_j + \mathbf{v}_j^T \tilde{\mathbf{G}}_{j,\alpha} \mathbf{u}_{j,\alpha} + \mathbf{v}_{j,\alpha}^T \mathbf{G}_j \mathbf{u}_{j,\beta} \\ & + s_{j,\alpha} (\mathbf{v}_j^T \mathbf{M} \mathbf{u}_j + \mathbf{v}_j^T \mathbf{M} \mathbf{u}_{j,\alpha} + 2\mathbf{v}_j^T \mathbf{M}_{,\alpha} \mathbf{u}_j) \} \end{aligned} \quad (87)$$

The difference in these constants is given by Equation (82).



Problems similar to this have been discussed by Brandon [15] in the context of undamped systems. One may verify that for undamped systems Equation (85) reduces to the equivalent expression derived in Reference [15].

### 7. AN EXAMPLE OF A SYMMETRIC SYSTEM

A simple two-degree-of-freedom system has been considered to illustrate a possible use of the expressions developed so far. Figure 1 shows the example, together with the numerical values of the masses, spring stiffnesses and damping. When the eigenvalues are plotted versus a system parameter they create family of ‘root loci’. When two loci approach each other they may cross or rapidly diverge. The latter case is called ‘curve veering’. It is known that during veering rapid changes take place in the eigensolutions and this produces an interesting example to apply the results derived in this paper.

The system matrices for the example are

$$\mathbf{M} = \begin{bmatrix} m & 0 \\ 0 & m \end{bmatrix}, \quad \mathbf{C} = \begin{bmatrix} c & -c \\ -c & c \end{bmatrix} \quad \text{and} \quad \mathbf{K} = \begin{bmatrix} k_1 + k_3 & -k_3 \\ -k_3 & k_2 + k_3 \end{bmatrix} \quad (88)$$

Because all the system matrices are symmetric the left and right eigenvectors are same in this case. We have focused our attention on calculating the first and second order derivatives of the complex eigenvalues with respect to the damping parameter ‘c’. The derivative of the system matrices with respect to this parameter may be obtained as

$$\frac{d\mathbf{M}}{dc} = \mathbf{0}, \quad \frac{d\mathbf{C}}{dc} = \begin{bmatrix} 1 & -1 \\ -1 & 1 \end{bmatrix} \quad \text{and} \quad \frac{d\mathbf{K}}{dc} = \mathbf{0} \quad (89)$$

Figure 2 shows the real parts (normalized by dividing with  $\sqrt{k_1/m}$ ) of the first derivative of the eigenvalues with respect to  $c$  over a parameter variation of  $k_2$ . This plot was obtained by the direct programming of Equation (30) in MATLAB™. The complex eigenvalues and eigenvectors

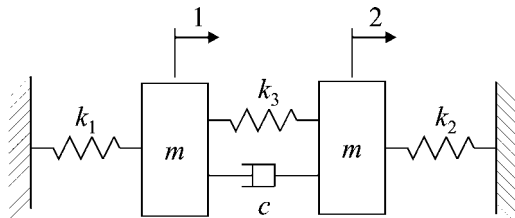

Figure 1. The two-degree-of-freedom discrete system,  $m = 1 \text{ kg}$ ,  $k_1 = 1000 \text{ N/m}$ ,  $k_3 = 20 \text{ N/m}$ ,  $c = 4.0 \text{ N s/m}$ .

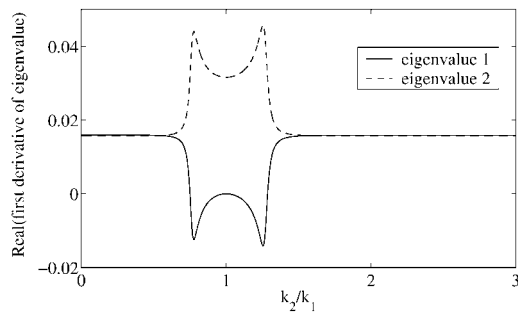

Figure 2. The real parts of first derivatives of the eigenvalues with respect to the damping parameter ( $c$ ) for the mass, spring damper system, normalized by  $-\sqrt{k_1/m}$ .

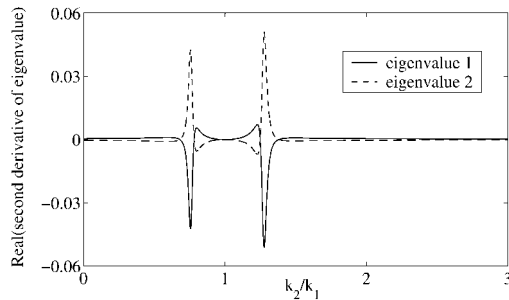

Figure 3. The real parts of second derivatives of the eigenvalues with respect to the damping parameter ( $c$ ) for the mass, spring damper system, normalized by  $-\sqrt{k_1/m}$ .

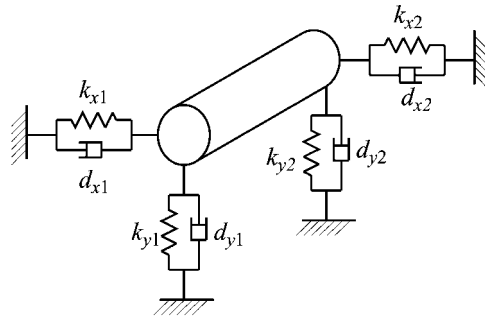

Figure 4. A schematic of the rigid rotor example.

appearing in this equation were obtained from the procedure outlined in Reference [31]. The real part has been chosen to be plotted here because a change in damping is expected to contribute to a significant change in the real part of the eigenvalue. Since the value of the connecting spring constant  $k_3$  is quite small, we expect a strong veering effect in this case. The change in the values of the derivatives around the veering region, that is when  $0.75 < k_2/k_1 < 1.25$ , shows that the both the natural frequencies are very sensitive to small changes in the value of  $c$ . This could be guessed intuitively: because  $k_3$  is small, the damper becomes the only 'connecting element' between the two masses, so any change made there is expected to have a strong effect.

The real parts of the second derivatives of the eigenvalues with respect to  $c$  over a parameter variation of  $k_2$  are shown in Figure 3. Equation (72) is applied to obtain these results. The first derivatives of the eigenvectors appearing in this equation are calculated using Equation (64). Observe the sharp changes in the value of the second derivatives in the veering region (when  $0.75 < k_2/k_1 < 1.25$ ). The near-zero value of the double derivatives outside this region indicates that the first derivatives are approximately constant, which may be verified from Figure 2. Note that the values of the second derivative in the veering region are about the same magnitude as the corresponding values of the first derivative. This illustrates that the second-order derivatives can not be neglected in this region.

## 8. AN EXAMPLE OF AN ASYMMETRIC SYSTEM

A simple rotating machinery example will now be used to demonstrate the calculation of eigensystem derivatives for asymmetric systems. Figure 4 shows a schematic of a rigid rotor on flexible supports. The rotor consists of a rigid cylinder of length 0.5 m, diameter 0.2 m and mass density  $7810 \text{ kg/m}^3$ . The rotor is supported in bearings that are modelled using springs and dashpots. The spring stiffnesses are  $k_{x1} = 1.6 \text{ GN/m}$ ,  $k_{x2} = 1.4 \text{ GN/m}$ ,  $k_{y1} = 1.1 \text{ GN/m}$  and  $k_{y2} = 1.6 \text{ GN/m}$ . The dashpots all have a damping coefficient of  $1 \text{ kN s/m}$ . For this exercise the four degrees of freedom are the lateral displacement of the rotor mass centre, and the

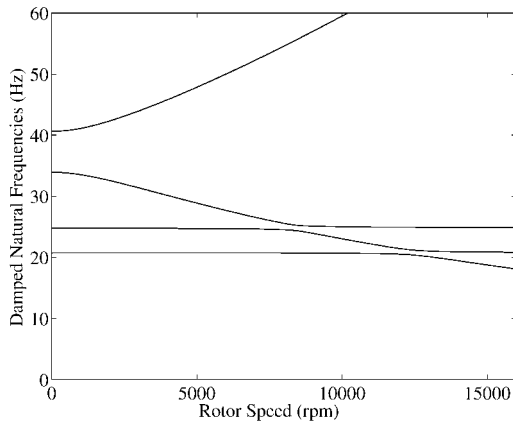

Figure 5. The Campbell diagram for the rotor example.

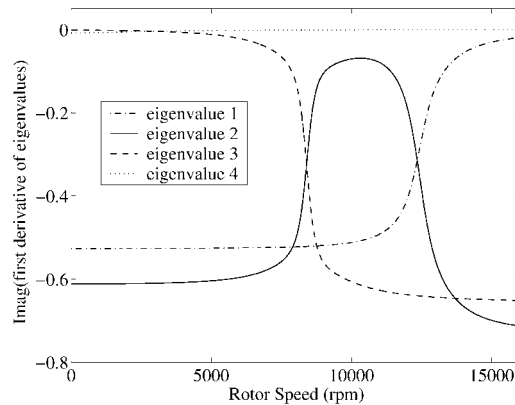

Figure 6. The imaginary part of the first derivative of the eigenvalues for the rotor example.

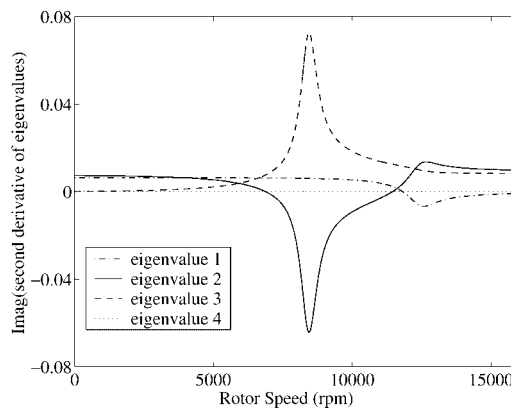

Figure 7. The imaginary part of the second derivative of the eigenvalues for the rotor example.

rotation about the two axes orthogonal to the rotor axis. The asymmetry in the equations of motions arises from the gyroscopic effects that increase with rotational speed. Figure 5 shows the Campbell diagram (the change in the damped natural frequency with rotor speed) and clearly shows that the gyroscopic effects are significant, particularly, in the higher modes. The asymmetric spring stiffnesses mean that the modes in the two lateral planes are not equal at zero speed, and this is clearly seen in Figure 5. Figures 6 and 7 show the imaginary parts of the first and second derivatives of the eigenvalues with respect to the rotor mass, respectively. The imaginary part is chosen because the rotor mass is likely to have a significant influence on the damped natural frequency. As expected the derivatives are large near the veering regions.

To demonstrate the calculation of the eigensystem derivatives a single rotor speed is chosen. A suitable speed is near one of the two veering regions at about 8300 and 12 500 rpm, where the natural frequencies become close. A rotor speed of 8300 rpm is chosen, which produces

Table I. The eigenvalues and their first and second derivatives for the rotor example.

Eigenvalues, $s_j$	$ds_j/dm$	$d^2s_j/dm^2$
$-8.2247 + 130.17i$	$0.068774 - 0.52184i$	$-1.2251 \times 10^{-3} + 6.0452 \times 10^{-3}i$
$-10.406 + 153.51i$	$0.33511 - 0.38926i$	$-2.4198 \times 10^{-2} - 5.5357 \times 10^{-2}i$
$-11.651 + 159.22i$	$-0.27082 - 0.25210i$	$2.3254 \times 10^{-2} + 6.3482 \times 10^{-2}i$
$-29.689 + 347.53i$	$-1.6848 \times 10^{-4} - 9.6179 \times 10^{-4}i$	$3.0769 \times 10^{-6} + 1.9497 \times 10^{-5}i$

the system matrices

$$\mathbf{M} = \begin{bmatrix} 122.68 & 0 & 0 & 0 \\ 0 & 122.68 & 0 & 0 \\ 0 & 0 & 2.8625 & 0 \\ 0 & 0 & 0 & 2.8625 \end{bmatrix} \quad (90)$$

$$\mathbf{C} = \begin{bmatrix} 2 & 0 & 0 & 0 \\ 0 & 2 & 0 & 0 \\ 0 & 0 & 0.125 & 0.53315 \\ 0 & 0 & -0.53315 & 0.125 \end{bmatrix} \quad (91)$$

and

$$\mathbf{K} = \begin{bmatrix} 2.1 & 0 & 0 & 0.025 \\ 0 & 3 & -0.05 & 0 \\ 0 & -0.05 & 0.1875 & 0 \\ 0.025 & 0 & 0 & 0.13125 \end{bmatrix} \quad (92)$$

Table I gives the eigenvalues for this system and Table II shows the second and third eigenvectors, where the left and right eigenvectors are normalised according to Equations (20) and (21), with  $\gamma_j = 1/2s_j$ . The second and third eigenvectors are chosen because the corresponding eigenvalues are close, as shown in Figure 5. Suppose we wish to take the derivatives of the eigensystem with respect to the rotor mass,  $m$ . Thus,

$$\frac{d\mathbf{M}}{dm} = \begin{bmatrix} 1 & 0 & 0 & 0 \\ 0 & 1 & 0 & 0 \\ 0 & 0 & 0 & 0 \\ 0 & 0 & 0 & 0 \end{bmatrix}, \quad \frac{d\mathbf{C}}{dm} = \mathbf{0} \quad \text{and} \quad \frac{d\mathbf{K}}{dm} = \mathbf{0} \quad (93)$$

Table I also gives the first and second derivatives of the eigenvalues and Table II gives the derivatives of the second and third eigenvectors with respect to the rotor mass. It is clear that the second derivatives are significant and should not be neglected at this rotor speed.

Table II. The second and third eigenvectors and their first and second derivatives for the rotor example.

$\mathbf{u}_2$	$d\mathbf{u}_2/dm$	$d^2\mathbf{u}_2/dm^2$
$7.2538 \times 10^{-3} - 4.5894 \times 10^{-3}i$	$-8.0043 \times 10^{-4} + 1.7854 \times 10^{-4}i$	$9.2346 \times 10^{-5} + 1.4436 \times 10^{-4}i$
$0.026271 - 0.077468i$	$-3.3198 \times 10^{-3} - 3.5156 \times 10^{-3}i$	$-2.6742 \times 10^{-4} + 1.4492 \times 10^{-3}i$
$-0.078310 - 0.20164i$	$-2.4789 \times 10^{-3} + 0.017494i$	$4.5493 \times 10^{-3} - 5.7370 \times 10^{-4}i$
$0.24732 - 0.12197i$	$-0.025341 - 1.4616 \times 10^{-3}i$	$1.4882 \times 10^{-3} + 6.3048 \times 10^{-3}i$
$\mathbf{v}_2$	$d\mathbf{v}_2/dm$	$d^2\mathbf{v}_2/dm^2$
$7.2538 \times 10^{-3} - 4.5894 \times 10^{-3}i$	$-8.0043 \times 10^{-4} + 1.7854 \times 10^{-4}i$	$9.2346 \times 10^{-5} + 1.4436 \times 10^{-4}i$
$-0.026271 + 0.077468i$	$3.3198 \times 10^{-3} + 3.5156 \times 10^{-3}i$	$2.6742 \times 10^{-4} - 1.4492 \times 10^{-3}i$
$0.078310 + 0.20164i$	$2.4789 \times 10^{-3} - 0.017494i$	$-4.5493 \times 10^{-3} + 5.7370 \times 10^{-4}i$
$0.24732 - 0.12197i$	$-0.025341 - 1.4616 \times 10^{-3}i$	$1.4882 \times 10^{-3} + 6.3048 \times 10^{-3}i$
$\mathbf{u}_3$	$d\mathbf{u}_3/dm$	$d^2\mathbf{u}_3/dm^2$
$8.4324 \times 10^{-3} + 1.6450 \times 10^{-3}i$	$2.1216 \times 10^{-4} - 5.0674 \times 10^{-4}i$	$-1.9000 \times 10^{-4} + 7.2052 \times 10^{-6}i$
$0.029840 + 0.061027i$	$3.0957 \times 10^{-4} - 6.2541 \times 10^{-3}i$	$-1.5355 \times 10^{-3} + 3.7855 \times 10^{-4}i$
$0.097315 - 0.22388i$	$-9.6786 \times 10^{-3} - 0.013136i$	$-1.3803 \times 10^{-3} + 4.5250 \times 10^{-3}i$
$0.33389 + 0.11301i$	$0.015577 - 0.013703i$	$-6.1042 \times 10^{-3} - 1.2157 \times 10^{-3}i$
$\mathbf{v}_3$	$d\mathbf{v}_3/dm$	$d^2\mathbf{v}_3/dm^2$
$8.4324 \times 10^{-3} + 1.6450 \times 10^{-3}i$	$2.1216 \times 10^{-4} - 5.0674 \times 10^{-4}i$	$-1.9000 \times 10^{-4} + 7.2052 \times 10^{-6}i$
$-0.029840 - 0.061027i$	$-3.0957 \times 10^{-4} + 6.2541 \times 10^{-3}i$	$1.5355 \times 10^{-3} - 3.7855 \times 10^{-4}i$
$-0.097315 + 0.22388i$	$9.6786 \times 10^{-3} + 0.013136i$	$1.3803 \times 10^{-3} - 4.5250 \times 10^{-3}i$
$0.33389 + 0.11301i$	$0.015577 - 0.013703i$	$-6.1042 \times 10^{-3} - 1.2157 \times 10^{-3}i$

## 9. CONCLUSION

In the presence of general non-conservative forces linear dynamic systems do not possess classical normal modes but possess complex modes. The first and joint second-order derivatives of the eigenvalues and eigenvectors of such systems have been derived. It is assumed that the mass matrix is non-singular and the system does not possess any repeated roots. The approach taken here avoids the use of the first-order formulation of the equations of motion and is consistent with traditional modal analysis procedures. For this reason the derived expressions can provide good physical insight and can be used effectively in model updating, damage detection and design optimization. The advantage is that the damping matrix is considered, in addition to the mass and stiffness matrices currently used. The results obtained here are very general in nature; undamped systems, symmetric non-conservative systems, and damped or undamped gyroscopic systems can be considered as special cases.

## APPENDIX. DETERMINATION OF THE COEFFICIENTS $c_{jk}^{(\alpha\beta)}$ AND $d_{jk}^{(\alpha\beta)}$

The coefficients  $c_{jk}^{(\alpha\beta)}$  and  $d_{jk}^{(\alpha\beta)}$ ,  $\forall k=1, \dots, 2N$ , in Equations (73) and (74) completely determine  $\mathbf{z}_{j,\alpha\beta}$  and  $\mathbf{y}_{j,\alpha\beta}$ . In Section 6 they are expressed in terms of the system property matrices and eigenvectors of the first-order system. In order to carry out a sensitivity analysis in ' $N$ '-space they must be related to the system property matrices and eigenvectors of the second-order system.

First, consider the expression for  $c_{jk}^{(\alpha\beta)}$ ,  $k \neq j$ , in Equation (77). Differentiating the expression of  $\mathcal{P}_j$  in Equation (27) with respect to  $g_\alpha$  one obtains

$$\mathcal{P}_{j,\alpha} = [\tilde{\mathcal{P}}_{j,\alpha} + s_{j,\alpha}\mathbf{A}], \quad \text{where } \tilde{\mathcal{P}}_{j,\alpha} = s_{j,\alpha}\mathcal{A}_{j,\alpha} + \mathcal{B}_{j,\alpha} \quad (\text{A1})$$

Differentiating again with respect to  $g_\beta$  gives

$$\mathcal{P}_{j,\alpha\beta} = [\mathcal{P}_{j,\alpha},\beta] = \tilde{\tilde{\mathcal{P}}}_{j,\alpha\beta} + s_{j,\beta}\mathcal{A}_{j,\alpha} + s_{j,\alpha}\mathcal{A}_{j,\beta} + s_{j,\alpha\beta}\mathcal{A} \quad (\text{A2})$$

Using the biorthogonality property of  $\mathbf{y}_k^T$  and  $\mathbf{z}_j$  the first term of the numerator of the right-hand side of (77) can be rewritten as

$$\mathbf{y}_k^T \mathcal{P}_{j,\alpha\beta} \mathbf{z}_j = \mathbf{y}_k^T \tilde{\tilde{\mathcal{P}}}_{j,\alpha\beta} \mathbf{z}_j + s_{j,\beta} \mathbf{y}_k^T \mathcal{A}_{j,\alpha} \mathbf{z}_j + s_{j,\alpha} \mathbf{y}_k^T \mathcal{A}_{j,\beta} \mathbf{z}_j \quad (\text{A3})$$

The terms appearing on the right side of this equation can be expressed in terms of the second-order eigensolutions and system properties. The first term reduces to

$$\begin{aligned} \mathbf{y}_k^T \tilde{\tilde{\mathcal{P}}}_{j,\alpha\beta} \mathbf{z}_j &= \begin{Bmatrix} \mathbf{v}_k \\ s_k \mathbf{v}_k \end{Bmatrix}^T \begin{bmatrix} s_j \mathbf{C}_{,\alpha\beta} + \mathbf{K}_{,\alpha\beta} & s_j \mathbf{M}_{,\alpha\beta} \\ s_j \mathbf{M}_{,\alpha\beta} & -\mathbf{M}_{,\alpha\beta} \end{bmatrix} \begin{Bmatrix} \mathbf{u}_j \\ s_j \mathbf{u}_j \end{Bmatrix} \\ &= \mathbf{v}_k^T [s_j^2 \mathbf{M}_{,\alpha\beta} + s_j \mathbf{C}_{,\alpha\beta} + \mathbf{K}_{,\alpha\beta}] \mathbf{u}_j \end{aligned} \quad (\text{A4})$$

The second term on the right side of Equation (A3) produces

$$\begin{aligned} s_{j,\beta} \mathbf{y}_k^T \mathcal{A}_{j,\alpha} \mathbf{z}_j &= s_{j,\beta} \begin{Bmatrix} \mathbf{v}_k \\ s_k \mathbf{v}_k \end{Bmatrix}^T \begin{bmatrix} \mathbf{C}_{,\alpha} & \mathbf{M}_{,\alpha} \\ \mathbf{M}_{,\alpha} & \mathbf{O} \end{bmatrix} \begin{Bmatrix} \mathbf{u}_j \\ s_j \mathbf{u}_j \end{Bmatrix} \\ &= s_{j,\beta} \mathbf{v}_k^T \mathbf{C}_{,\alpha} \mathbf{u}_j + s_{j,\beta} (s_j + s_k) \mathbf{v}_k^T \mathbf{M}_{,\alpha} \mathbf{u}_j \end{aligned} \quad (\text{A5})$$

Similarly expressing the last term, Equation (A3) can be represented in terms of the second-order eigensolutions and system properties as

$$\begin{aligned} \mathbf{y}_k^T \mathcal{P}_{j,\alpha\beta} \mathbf{z}_j &= \mathbf{v}_k^T [s_j^2 \mathbf{M}_{,\alpha\beta} + s_j \mathbf{C}_{,\alpha\beta} + \mathbf{K}_{,\alpha\beta}] \mathbf{u}_j + s_{j,\beta} \mathbf{v}_k^T \mathbf{C}_{,\alpha} \mathbf{u}_j \\ &\quad + s_{j,\beta} (s_j + s_k) \mathbf{v}_k^T \mathbf{M}_{,\alpha} \mathbf{u}_j + s_{j,\alpha} \mathbf{v}_k^T \mathbf{C}_{,\beta} \mathbf{u}_j + s_{j,\alpha} (s_j + s_k) \mathbf{v}_k^T \mathbf{M}_{,\beta} \mathbf{u}_j \end{aligned} \quad (\text{A6})$$

Now differentiating the expression for  $\mathbf{z}_j$  in Equation (11) with respect to  $g_\beta$  gives

$$\mathbf{z}_{j,\beta} = \begin{Bmatrix} \mathbf{u}_{j,\beta} \\ s_{j,\beta} \mathbf{u}_j + s_j \mathbf{u}_{j,\beta} \end{Bmatrix} \quad (\text{A7})$$

Using this relationship, the second term in the numerator expression for  $c_{jk}^{(\alpha\beta)}$ ,  $k \neq j$ , in Equation (77) can be expressed as

$$\mathbf{y}_k^T \mathcal{P}_{j,\alpha} \mathbf{z}_{j,\beta} = \begin{Bmatrix} \mathbf{v}_k \\ s_k \mathbf{v}_k \end{Bmatrix}^T \begin{bmatrix} s_j \mathbf{C}_{,\alpha} + \mathbf{K}_{,\alpha} + s_{j,\alpha} \mathbf{C} & s_j \mathbf{M}_{,\alpha} + s_{j,\alpha} \mathbf{M} \\ s_j \mathbf{M}_{,\alpha} + s_{j,\alpha} \mathbf{M} & -\mathbf{M}_{,\alpha} \end{bmatrix} \begin{Bmatrix} \mathbf{u}_{j,\beta} \\ s_{j,\beta} \mathbf{u}_{j,\beta} + s_j \mathbf{u}_{j,\beta} \end{Bmatrix}$$

$$\begin{aligned}
 &= \mathbf{v}_k^T [s_j^2 \mathbf{M}_{,\alpha} + s_j \mathbf{C}_{,\alpha} + \mathbf{K}_{,\alpha}] \mathbf{u}_{j,\beta} + s_{j,\alpha} \mathbf{v}_k^T \mathbf{C} \mathbf{u}_{j,\beta} + s_{j,\beta} (s_j - s_k) \mathbf{v}_k^T \mathbf{M}_{,\alpha} \mathbf{u}_j \\
 &\quad + s_{j,\alpha} (s_j + s_k) \mathbf{v}_k^T \mathbf{M} \mathbf{u}_{j,\beta} + s_{j,\alpha} s_{j,\beta} \mathbf{v}_k^T \mathbf{M} \mathbf{u}_j
 \end{aligned} \tag{A8}$$

Similarly, the last term in the numerator of the right-hand side of Equation (77) can also be expressed in terms of the second-order eigensolutions. Now from Equations (A6), (A8) and (77) we finally have

$$\begin{aligned}
 c_{jk}^{(\alpha\beta)} &= -\frac{1}{(s_j - s_k) \mathbf{v}_k^T [2s_k \mathbf{M} + \mathbf{C}] \mathbf{u}_k} \{ \mathbf{v}_k^T [s_j^2 \mathbf{M}_{,\alpha\beta} + s_j \mathbf{C}_{,\alpha\beta} + \mathbf{K}_{,\alpha\beta}] \mathbf{u}_j \\
 &\quad + \mathbf{v}_k^T [s_j^2 \mathbf{M}_{,\alpha} + s_j \mathbf{C}_{,\alpha} + \mathbf{K}_{,\alpha}] \mathbf{u}_{j,\beta} + \mathbf{v}_k^T [s_j^2 \mathbf{M}_{,\beta} + s_j \mathbf{C}_{,\beta} + \mathbf{K}_{,\beta}] \mathbf{u}_{j,\alpha} \\
 &\quad + s_{j,\alpha} (s_j + s_k) (\mathbf{v}_k^T \mathbf{M}_{,\beta} \mathbf{u}_j + \mathbf{v}_k^T \mathbf{M} \mathbf{u}_{j,\beta}) + s_{j,\beta} (s_j + s_k) (\mathbf{v}_k^T \mathbf{M}_{,\alpha} \mathbf{u}_j + \mathbf{v}_k^T \mathbf{M} \mathbf{u}_{j,\alpha}) \\
 &\quad + (s_j - s_k) (s_{j,\beta} \mathbf{v}_k^T \mathbf{M}_{,\alpha} \mathbf{u}_j + s_{j,\alpha} \mathbf{v}_k^T \mathbf{M}_{,\beta} \mathbf{u}_j) + s_{j,\alpha} (\mathbf{v}_k^T \mathbf{C}_{,\beta} \mathbf{u}_j + \mathbf{v}_k^T \mathbf{C} \mathbf{u}_{j,\beta}) \\
 &\quad + s_{j,\beta} (\mathbf{v}_k^T \mathbf{C}_{,\alpha} \mathbf{u}_j + \mathbf{v}_k^T \mathbf{C} \mathbf{u}_{j,\alpha}) + 2s_{j,\alpha} s_{j,\beta} \mathbf{v}_k^T \mathbf{M} \mathbf{u}_j \}, \quad \forall k = 1, \dots, 2N, \quad k \neq j
 \end{aligned} \tag{A9}$$

For the left eigenvectors the coefficients  $d_{jk}^{(\alpha\beta)}$ ,  $k \neq j$  can be obtained from Equation (78). Following a similar procedure used to obtain  $c_{jk}^{(\alpha\beta)}$  we can represent  $d_{jk}^{(\alpha\beta)}$  in terms of the second-order eigenvectors and their derivatives and the derivatives of the system property matrices as

$$\begin{aligned}
 d_{jk}^{(\alpha\beta)} &= -\frac{1}{(s_j - s_k) \mathbf{v}_k^T [2s_k \mathbf{M} + \mathbf{C}] \mathbf{u}_k} \times \{ \mathbf{v}_k^T [s_j^2 \mathbf{M}_{,\alpha\beta} + s_j \mathbf{C}_{,\alpha\beta} + \mathbf{K}_{,\alpha\beta}] \mathbf{u}_k \\
 &\quad + \mathbf{v}_{j,\beta}^T [s_j^2 \mathbf{M}_{,\alpha} + s_j \mathbf{C}_{,\alpha} + \mathbf{K}_{,\alpha}] \mathbf{u}_k + \mathbf{v}_{j,\alpha}^T [s_j^2 \mathbf{M}_{,\beta} + s_j \mathbf{C}_{,\beta} + \mathbf{K}_{,\beta}] \mathbf{u}_k \\
 &\quad + s_{j,\alpha} (s_j + s_k) (\mathbf{v}_j^T \mathbf{M}_{,\beta} \mathbf{u}_k + \mathbf{v}_{j,\beta}^T \mathbf{M} \mathbf{u}_k) + s_{j,\beta} (s_j + s_k) (\mathbf{v}_j^T \mathbf{M}_{,\alpha} \mathbf{u}_k + \mathbf{v}_{j,\alpha}^T \mathbf{M} \mathbf{u}_k) \\
 &\quad + (s_j - s_k) (s_{j,\beta} \mathbf{v}_j^T \mathbf{M}_{,\alpha} \mathbf{u}_k + s_{j,\alpha} \mathbf{v}_j^T \mathbf{M}_{,\beta} \mathbf{u}_k) + s_{j,\alpha} (\mathbf{v}_j^T \mathbf{C}_{,\beta} \mathbf{u}_k + \mathbf{v}_{j,\beta}^T \mathbf{C} \mathbf{u}_k) \\
 &\quad + s_{j,\beta} (\mathbf{v}_j^T \mathbf{C}_{,\alpha} \mathbf{u}_k + \mathbf{v}_{j,\alpha}^T \mathbf{C} \mathbf{u}_k) + 2s_{j,\alpha} s_{j,\beta} \mathbf{v}_j^T \mathbf{M} \mathbf{u}_k \}, \quad \forall k = 1, \dots, 2N, \quad k \neq j
 \end{aligned} \tag{A10}$$

Now consider the coefficients  $c_{jj}^{(\alpha\beta)}$  and  $d_{jj}^{(\alpha\beta)}$  expressed in Equations (80) and (82). All the terms appearing in the numerator of the right side of Equation (80) can be expressed in terms of system property matrices, second-order eigenvectors and their derivatives. To illustrate the procedure for a typical term consider the (third) term  $\mathbf{y}_{j,\beta}^T \mathcal{A} \mathbf{z}_{j,\alpha}$ . Using the expression of  $\mathbf{z}_{j,\alpha}$  (and similarly for  $\mathbf{y}_{j,\beta}$  also) in Equation (A7) one has

$$\begin{aligned}
 \mathbf{y}_{j,\beta}^T \mathcal{A} \mathbf{z}_{j,\alpha} &= \left\{ \begin{array}{c} \mathbf{v}_{j,\beta} \\ s_{j,\beta} \mathbf{v}_j + s_j \mathbf{v}_{j,\beta} \end{array} \right\}^T \begin{bmatrix} \mathbf{C} & \mathbf{M} \\ \mathbf{M} & \mathbf{O} \end{bmatrix} \left\{ \begin{array}{c} \mathbf{u}_{j,\alpha} \\ s_{j,\alpha} \mathbf{u}_j + s_j \mathbf{u}_{j,\alpha} \end{array} \right\} \\
 &= \mathbf{v}_{j,\beta}^T [\mathbf{C} + 2s_j \mathbf{M}] \mathbf{u}_{j,\alpha} + s_{j,\alpha} \mathbf{v}_{j,\beta}^T \mathbf{M} \mathbf{u}_j + s_{j,\beta} \mathbf{v}_j^T \mathbf{M} \mathbf{u}_{j,\alpha}
 \end{aligned} \tag{A11}$$

Expressing the other terms using a similar procedure, Equation (80) becomes

$$\begin{aligned}
 c_{jj}^{(\alpha\beta)} + d_{jj}^{(\alpha\beta)} = & -\frac{1}{2\mathbf{v}_j^T[s_j\mathbf{M} + \mathbf{C}]\mathbf{u}_j} \times \{ \mathbf{v}_j^T[2s_j\mathbf{M}_{,\alpha\beta} + \mathbf{C}_{,\alpha\beta}]\mathbf{u}_j + \mathbf{v}_{j,\alpha}^T[2s_j\mathbf{M}_{,\beta} + \mathbf{C}_{,\beta}]\mathbf{u}_j \\
 & + \mathbf{v}_j^T[2s_j\mathbf{M}_{,\beta} + \mathbf{C}_{,\beta}]\mathbf{u}_{j,\alpha} + \mathbf{v}_{j,\beta}^T[2s_j\mathbf{M}_{,\alpha} + \mathbf{C}_{,\alpha}]\mathbf{u}_j + \mathbf{v}_j^T[2s_j\mathbf{M}_{,\alpha} + \mathbf{C}_{,\alpha}]\mathbf{u}_{j,\beta} \\
 & + \mathbf{v}_{j,\alpha}^T[2s_j\mathbf{M} + \mathbf{C}]\mathbf{u}_{j,\beta} + \mathbf{v}_{j,\beta}^T[2s_j\mathbf{M} + \mathbf{C}]\mathbf{u}_{j,\alpha} + s_{j,\alpha}(\mathbf{v}_{j,\beta}^T\mathbf{M}\mathbf{u}_j + \mathbf{v}_j^T\mathbf{M}\mathbf{u}_{j,\beta} + 2\mathbf{v}_j^T\mathbf{M}_\alpha\mathbf{u}_j) \\
 & + s_{j,\beta}(\mathbf{v}_{j,\alpha}^T\mathbf{M}\mathbf{u}_j + \mathbf{v}_j^T\mathbf{M}\mathbf{u}_{j,\alpha} + 2\mathbf{v}_j^T\mathbf{M}_\alpha\mathbf{u}_j) \} \quad (\text{A12})
 \end{aligned}$$

With the above definitions, and Equation (82),  $c_{jj}^{(\alpha\beta)}$  and  $d_{jj}^{(\alpha\beta)}$ ,  $\forall k = 1, \dots, 2N$ , are expressed in terms of the system property matrices, eigenvectors and their first derivatives of the second-order system.

#### ACKNOWLEDGEMENTS

The first author is grateful to the Nehru Memorial Trust, London and Cambridge Commonwealth Trust for providing financial support for this research. The second author acknowledges the support of the EPSRC through the award of an Advanced Fellowship.

#### REFERENCES

1. Fox RL, Kapoor MP. Rates of change of eigenvalues and eigenvectors. *AIAA Journal* 1968; **6**(12):2426–2429.
2. Rogers LC. Derivatives of eigenvalues and eigenvectors. *AIAA Journal* 1970; **8**(5):943–944.
3. Plaut RH, Huseyin K. Derivative of eigenvalues and eigenvectors in non-self adjoint systems. *AIAA Journal* 1973; **11**(2):250–251.
4. Garg S. Derivatives of eigensolutions for a general matrix. *AIAA Journal* 1973; **11**(8):1191–1194.
5. Rudisill CS. Derivatives of eigenvalues and eigenvectors for a general matrix. *AIAA Journal* 1974; **12**(5):721–722.
6. Nelson RB. Simplified calculation of eigenvector derivatives. *AIAA Journal* 1976; **14**(9):1201–1205.
7. Murthy DV, Haftka RT. Derivatives of eigenvalues and eigenvectors of a general complex matrix. *International Journal for Numerical Methods in Engineering* 1988; **26**(2):293–311.
8. Zeng QH. Highly accurate modal method for calculating eigenvector derivatives in viscous damping systems. *AIAA Journal* 1995; **33**(4):746–751.
9. Bhaskar A. Rayleigh's classical sensitivity analysis extended to damped and gyroscopic systems. In *IUTAM-IITD International Winter School on Optimum Dynamic Design Using Modal Testing and Structural Dynamic Modification*, Nakra BC, Kundra TK (eds). Delhi Press: Delhi, India, 1997; 417–430.
10. Lee IW, Kim DO, Jung HH. Natural frequency and mode shape sensitivities of damped systems: Part I, distinct natural frequencies. *Journal of Sound and Vibration* 1999; **223**(3):399–412.
11. Lee IW, Kim DO, Jung HH. Natural frequency and mode shape sensitivities of damped systems: Part II, multiple natural frequencies. *Journal of Sound and Vibration* 1999; **223**(3):413–424.
12. Adhikari S. Rates of change of eigenvalues and eigenvectors in damped dynamics system. *AIAA Journal* 1999; **37**(11):1152–1158.
13. Adhikari S. Calculation of derivative of complex modes using classical normal modes. *Computer and Structures* 2000; **77**(6):625–633.
14. Brandon JA. Derivation and significance of second-order modal design sensitivities. *AIAA Journal* 1984; **22**(5):723–724.
15. Brandon JA. Second-order design sensitivities to assess the applicability of sensitivity analysis. *AIAA Journal* 1991; **29**(1):135–139.
16. Chen SH, Qiu Z, Liu Z. Perturbation method for computing eigenvalue bounds in structural vibration systems with interval parameters. *Communications in Numerical Methods in Engineering* 1994; **10**(2):121–134.
17. Chen SH, Song DT, Ma AJ. Eigensolution reanalysis of modified structures using perturbations and Rayleigh quotients. *Communications in Numerical Methods in Engineering* 1994; **10**(2):111–119.



18. Friswell MI. Calculation of second and higher order eigenvector derivatives. *Journal of Guidance, Control and Dynamics* 1995; **18**(4):919–921.
19. Mills-Curran WC. Calculation of eigenvector derivatives for structures with repeated eigenvalues. *AIAA Journal* 1988; **26**(7):867–871.
20. Dailey RL. Eigenvector derivatives with repeated eigenvalues. *AIAA Journal* 1989; **27**(4):486–491.
21. Friswell MI. The derivatives of repeated eigenvalues and their associated eigenvectors. *ASME Journal of Vibration and Acoustics* 1996; **118**(3):390–397.
22. Prells U, Friswell MI. Calculating derivatives of repeated and nonrepeated eigenvalues without explicit use of eigenvectors. *AIAA Journal* 2000; **38**(8):1426–1436.
23. Prells U, Friswell MI. A relationship between defective systems and unit-rank modification of classical damping. *Journal of Vibration and Acoustics* 2000; **122**(2):180–183.
24. Friswell MI, Prells U. Non-proportional damping and defective systems. *ISMA 25*, Leuven, Belgium, September 2000; 309–315.
25. Lancaster P. *Lambda-matrices and Vibrating System*. Pergamon Press: London, 1966.
26. Newland DE. *Mechanical Vibration Analysis and Computation*. Longman, Harlow and Wiley: New York, 1989.
27. Meirovitch L. *Computational Methods in Structural Dynamics*. Sijthoff & Noordhoff: Netherlands, 1980.
28. Ma F, Caughey TK. Analysis of linear conservative vibration. *ASME Journal of Applied Mechanics* 1995; **62**: 685–691.
29. Meirovitch L, Ryland G. A perturbation technique for gyroscopic systems with small internal and external damping. *Journal of Sound and Vibration* 1985; **100**(3):393–408.
30. Malone DP, Cronin DL, Randolph TW. Eigenvalue and eigenvector determination for damped gyroscopic system. *ASME Journal of Applied Mechanics* 1997; **64**:710–712.
31. Adhikari S. Modal analysis of linear asymmetric non-conservative systems. *ASCE Journal of Engineering Mechanics* 1999; **125**(12):1372–1379.
32. Rudisill CS, Bhatia KG. Second derivatives of the flutter velocity and the optimization of aircraft structures. *AIAA Journal* 1972; **10**(12):1569–1572.
33. Rudisill CS, Chu YY. Numerical methods for evaluating the derivatives of eigenvalues and eigenvectors. *AIAA Journal* 1975; **13**(6):834–837.